

THE INFORMATION CONTAINED IN THIS DRAWING IS THE SOLE PROPERTY OF ABBOTT WORKHOLDING PRODUCTS. ANY REPRODUCTION IN PART OR WHOLE WITHOUT THE WRITTEN PERMISSION OF ABBOTT WORKHOLDING PRODUCTS IS PROHIBITED.

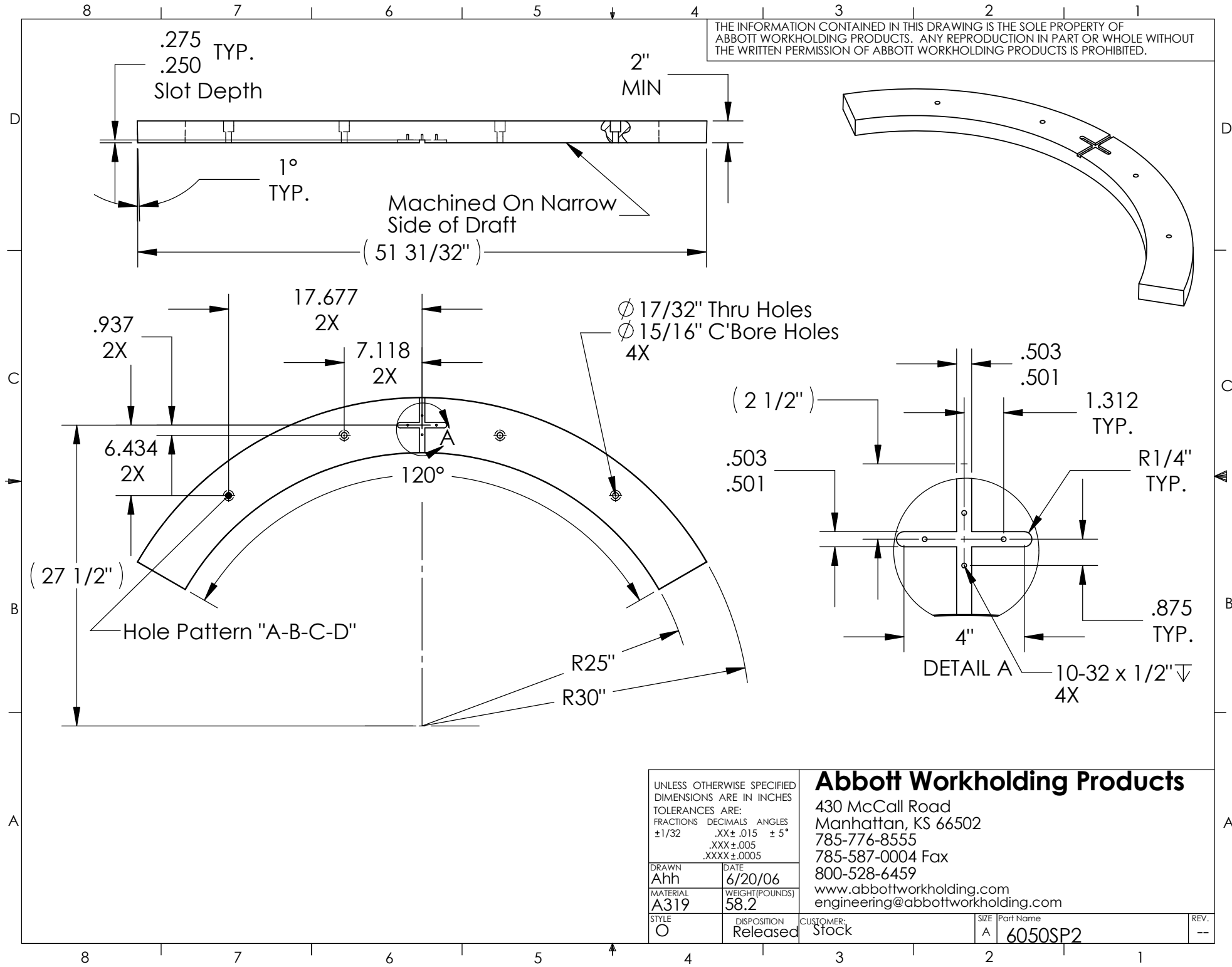

UNLESS OTHERWISE SPECIFIED
DIMENSIONS ARE IN INCHES
TOLERANCES ARE:
FRACTIONS DECIMALS ANGLES
±1/32 .XX±.015 ±5°
.XXX±.005
.XXXX±.0005

DRAWN Ahh	DATE 6/20/06
MATERIAL A319	WEIGHT(POUNDS) 58.2
STYLE O	DISPOSITION Released

Abbott Workholding Products

430 McCall Road
Manhattan, KS 66502
785-776-8555
785-587-0004 Fax
800-528-6459
www.abbottworkholding.com
engineering@abbottworkholding.com

CUSTOMER: Stock	SIZE A	Part Name 6050SP2	REV. --
--------------------	-----------	----------------------	------------