

THE INFORMATION CONTAINED IN THIS DRAWING IS THE SOLE PROPERTY OF ABBOTT WORKHOLDING PRODUCTS. ANY REPRODUCTION IN PART OR WHOLE WITHOUT THE WRITTEN PERMISSION OF ABBOTT WORKHOLDING PRODUCTS IS PROHIBITED.

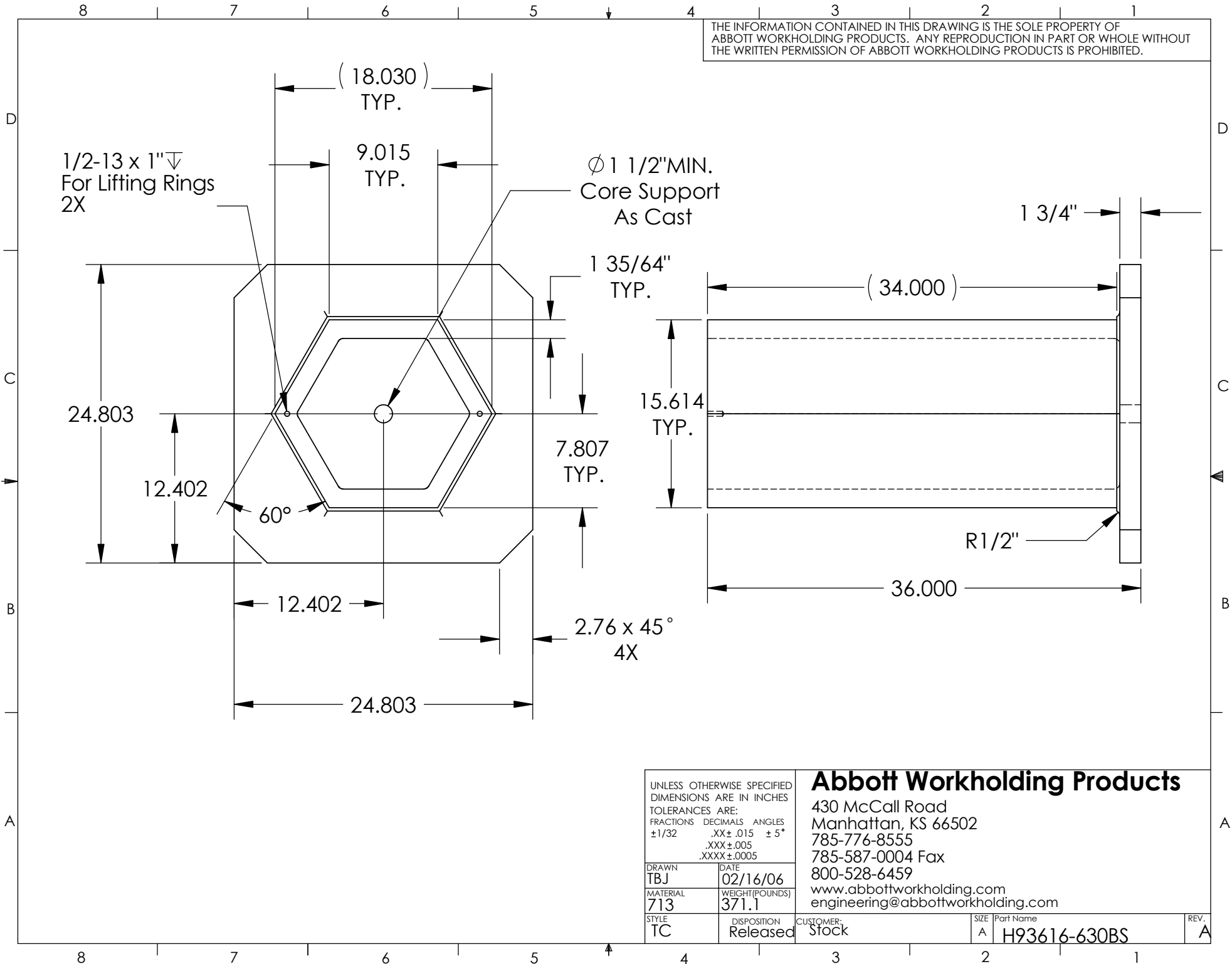

UNLESS OTHERWISE SPECIFIED
DIMENSIONS ARE IN INCHES
TOLERANCES ARE:
FRACTIONS DECIMALS ANGLES
±1/32 .XX±.015 ±5°
.XXX±.005
.XXXX±.0005

DRAWN TBJ	DATE 02/16/06
MATERIAL 713	WEIGHT (POUNDS) 371.1
STYLE TC	DISPOSITION Released

Abbott Workholding Products

430 McCall Road
Manhattan, KS 66502
785-776-8555
785-587-0004 Fax
800-528-6459

www.abbottworkholding.com
engineering@abbottworkholding.com

CUSTOMER: Stock	SIZE A	Part Name H93616-630BS	REV. A
--------------------	-----------	---------------------------	-----------