

THE INFORMATION CONTAINED IN THIS DRAWING IS THE SOLE PROPERTY OF ABBOTT WORKHOLDING PRODUCTS. ANY REPRODUCTION IN PART OR WHOLE WITHOUT THE WRITTEN PERMISSION OF ABBOTT WORKHOLDING PRODUCTS IS PROHIBITED.

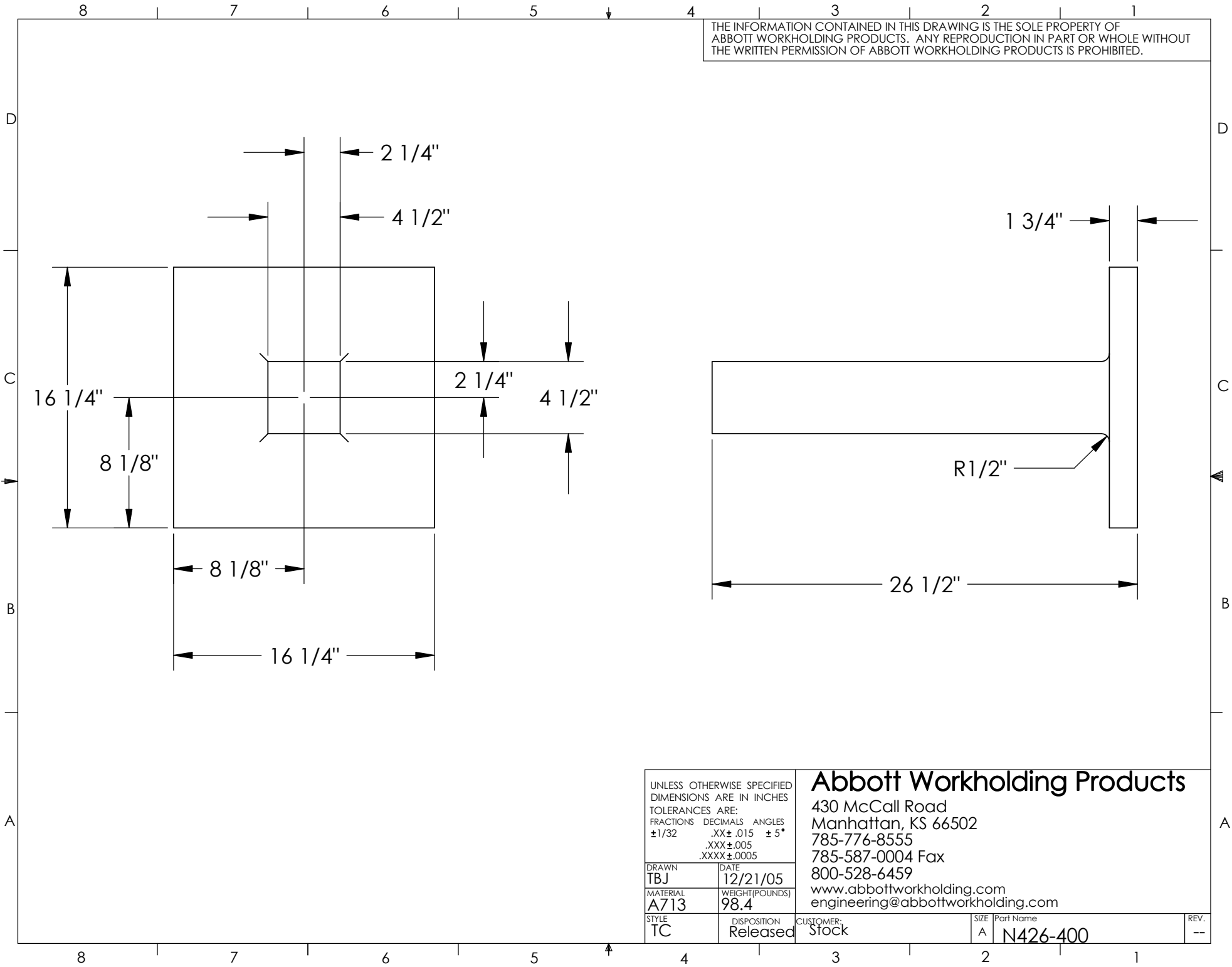

UNLESS OTHERWISE SPECIFIED DIMENSIONS ARE IN INCHES TOLERANCES ARE: FRACTIONS DECIMALS ANGLES ±1/32 .XX±.015 ±5° .XXX±.005 .XXXX±.0005		Abbott Workholding Products 430 McCall Road Manhattan, KS 66502 785-776-8555 785-587-0004 Fax 800-528-6459 www.abbottworkholding.com engineering@abbottworkholding.com		
DRAWN TBJ	DATE 12/21/05			
MATERIAL A713	WEIGHT(POUNDS) 98.4	CUSTOMER: Stock	SIZE A	Part Name N426-400
STYLE TC	DISPOSITION Released			REV. --