

THE INFORMATION CONTAINED IN THIS DRAWING IS THE SOLE PROPERTY OF ABBOTT WORKHOLDING PRODUCTS. ANY REPRODUCTION IN PART OR WHOLE WITHOUT THE WRITTEN PERMISSION OF ABBOTT WORKHOLDING PRODUCTS IS PROHIBITED.

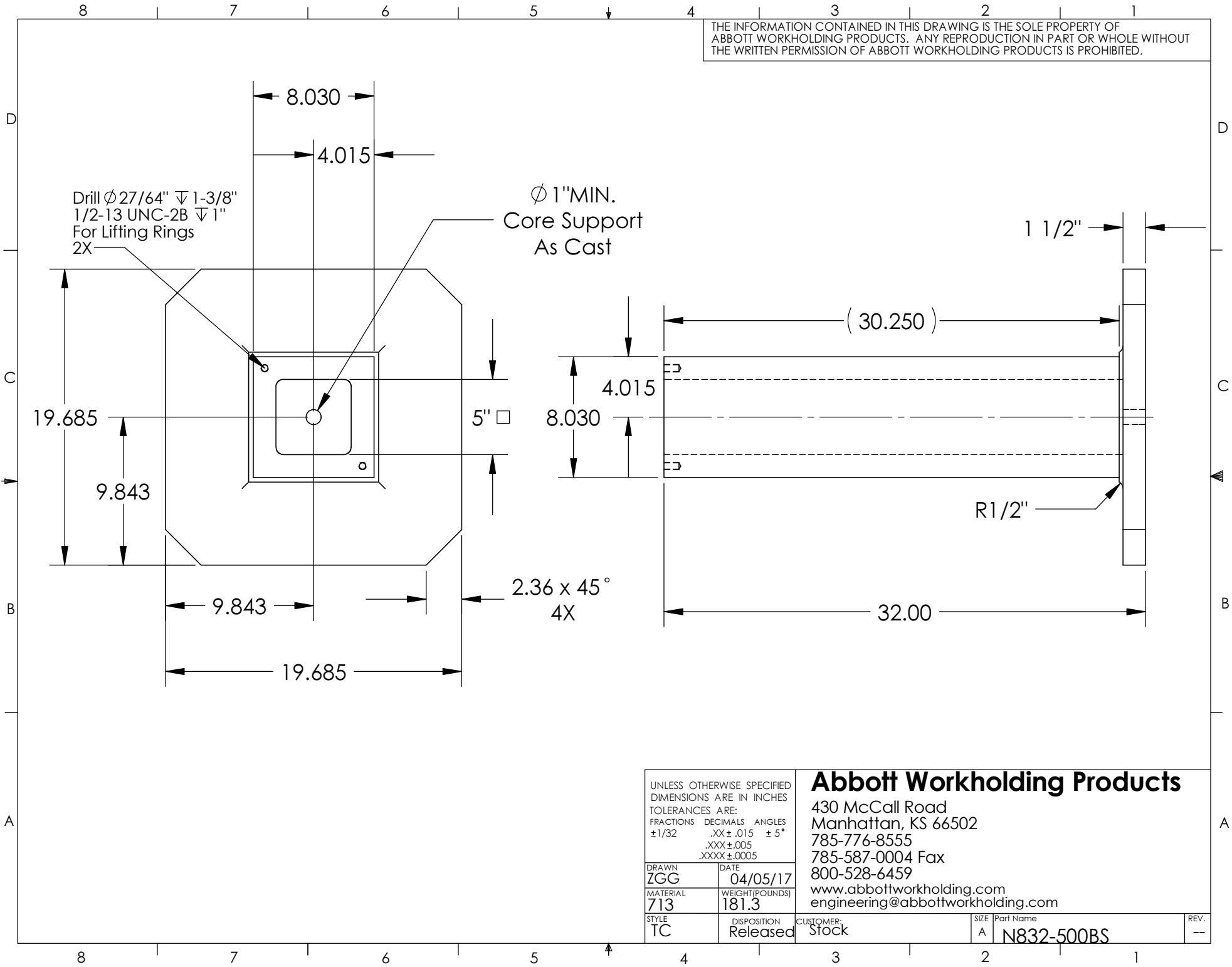

UNLESS OTHERWISE SPECIFIED
 DIMENSIONS ARE IN INCHES
 TOLERANCES ARE:
 FRACTIONS DECIMALS ANGLES
 $\pm 1/32$.XX $\pm .015$ $\pm 5^\circ$
 .XXX $\pm .005$
 .XXXX $\pm .0005$

DRAWN ZGG	DATE 04/05/17
MATERIAL 713	WEIGHT (POUNDS) 181.3
STYLE TC	DISPOSITION Released

Abbott Workholding Products

430 McCall Road
 Manhattan, KS 66502
 785-776-8555
 785-587-0004 Fax
 800-528-6459
www.abbottworkholding.com
engineering@abbottworkholding.com

CUSTOMER: Stock	SIZE A	Part Name N832-500BS	REV. --
--------------------	-----------	-------------------------	------------