

### #6 CHICK GRIPPER

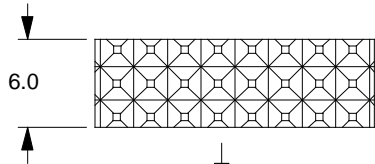

<u>Chick Cat.</u>	<u>Description</u>	<u>List \$</u>
005-2561	M6 Plain Gripper	\$26.00
005-2562	M6 Serrated Gripper	\$29.00

### #5 CHICK GRIPPER

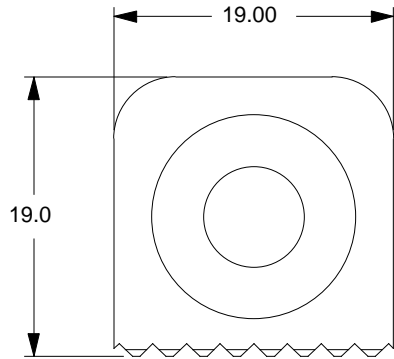
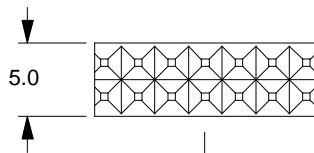
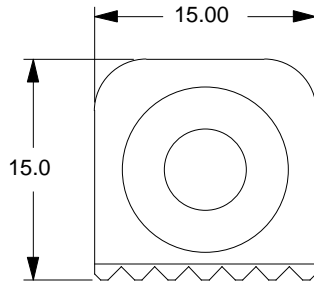

<u>Chick Cat.</u>	<u>Description</u>	<u>List \$</u>
005-2551	M5 Plain Gripper	\$22.00
005-2552	M5 Serrated Gripper	\$25.00

### #4 CHICK GRIPPER

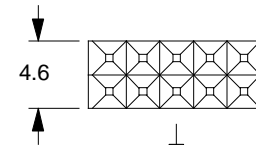
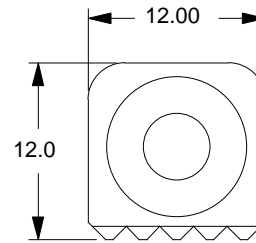

<u>Chick Cat.</u>	<u>Description</u>	<u>List \$</u>
005-2541	M4 Plain Gripper	\$21.00
005-2542	M4 Serrated Gripper	\$22.00

### #3 CHICK GRIPPER

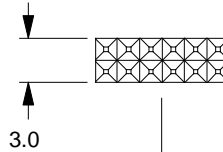
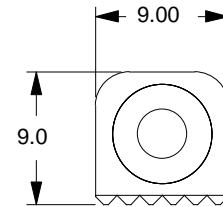

<u>Chick Cat.</u>	<u>Description</u>	<u>List \$</u>
005-2531	M3 Plain Gripper	\$19.00
005-2532	M3 Serrated Gripper	\$20.00

**GRIPPER SPECIFICATIONS:**

MAT'L: M2 H.S.S. HARDENED TO Rc 59-63

FINISH: BLACK OXIDE

CHICK GRIPPERS ARE AVAILABLE WITH SERRATED FACES (AS SHOWN) AND FLAT FACES (NOT SHOWN)

SEE DRAWING 250-0365-01 FOR INSTALLATION INSTRUCTION

<b>CHICK</b> Workholding Solutions Inc. 500 Keystone Drive Warrendale PA 15086 USA.		
<b>CHICK GRIPPERS DIMENSIONAL INFO</b>		
JAL	1 OF 1	800-0141
6 JUN 99		