

THE INFORMATION CONTAINED IN THIS DRAWING IS THE SOLE PROPERTY OF ABBOTT WORKHOLDING PRODUCTS. ANY REPRODUCTION IN PART OR WHOLE WITHOUT THE WRITTEN PERMISSION OF ABBOTT WORKHOLDING PRODUCTS IS PROHIBITED.

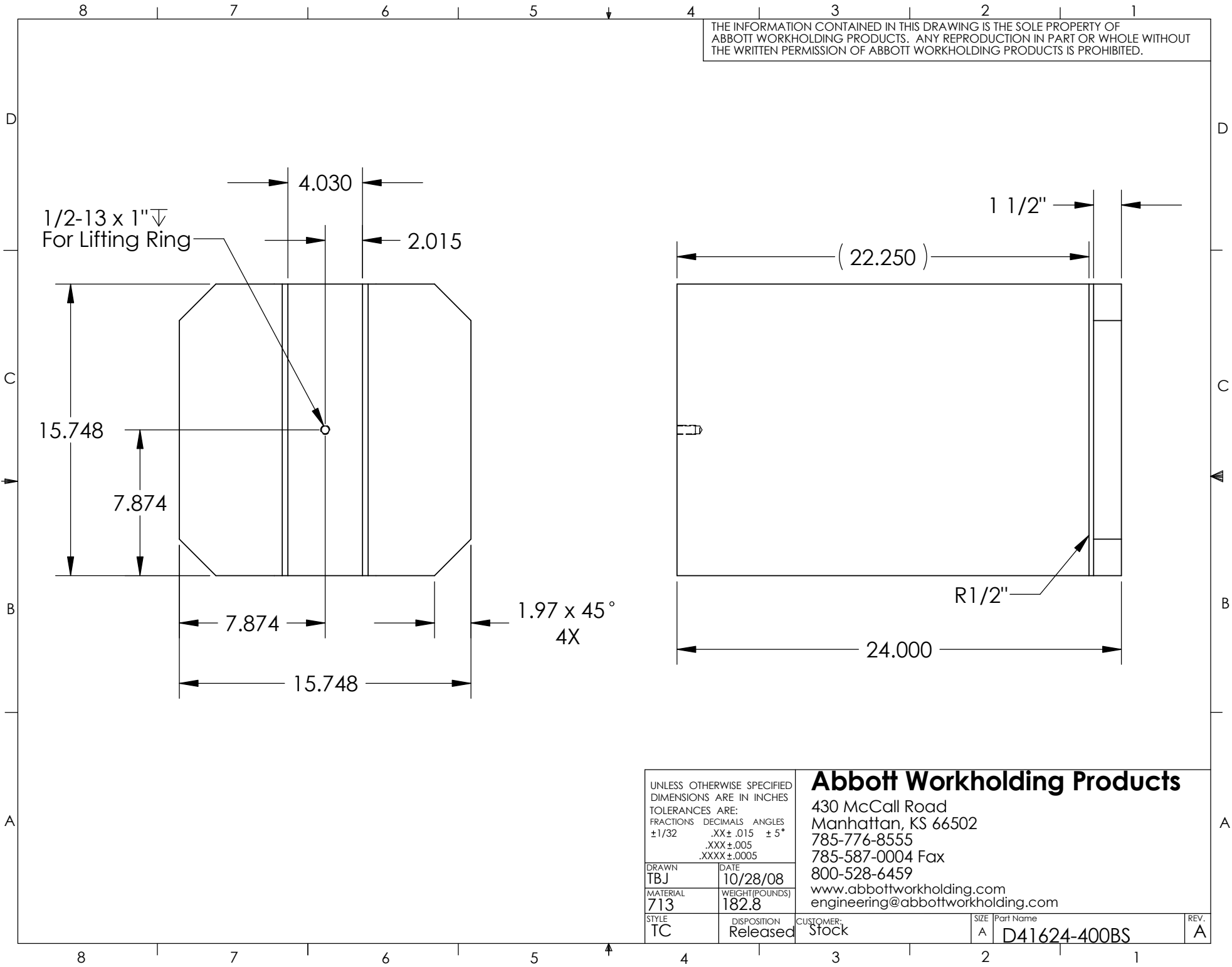

UNLESS OTHERWISE SPECIFIED
DIMENSIONS ARE IN INCHES
TOLERANCES ARE:
FRACTIONS DECIMALS ANGLES
±1/32 .XX±.015 ±5°
.XXX±.005
.XXXX±.0005

DRAWN TBJ	DATE 10/28/08
MATERIAL 713	WEIGHT(POUNDS) 182.8
STYLE TC	DISPOSITION Released

Abbott Workholding Products

430 McCall Road
Manhattan, KS 66502
785-776-8555
785-587-0004 Fax
800-528-6459
www.abbottworkholding.com
engineering@abbottworkholding.com

CUSTOMER: Stock	SIZE A	Part Name D41624-400BS	REV. A
--------------------	-----------	---------------------------	-----------