

THE INFORMATION CONTAINED IN THIS DRAWING IS THE SOLE PROPERTY OF ABBOTT WORKHOLDING PRODUCTS. ANY REPRODUCTION IN PART OR WHOLE WITHOUT THE WRITTEN PERMISSION OF ABBOTT WORKHOLDING PRODUCTS IS PROHIBITED.

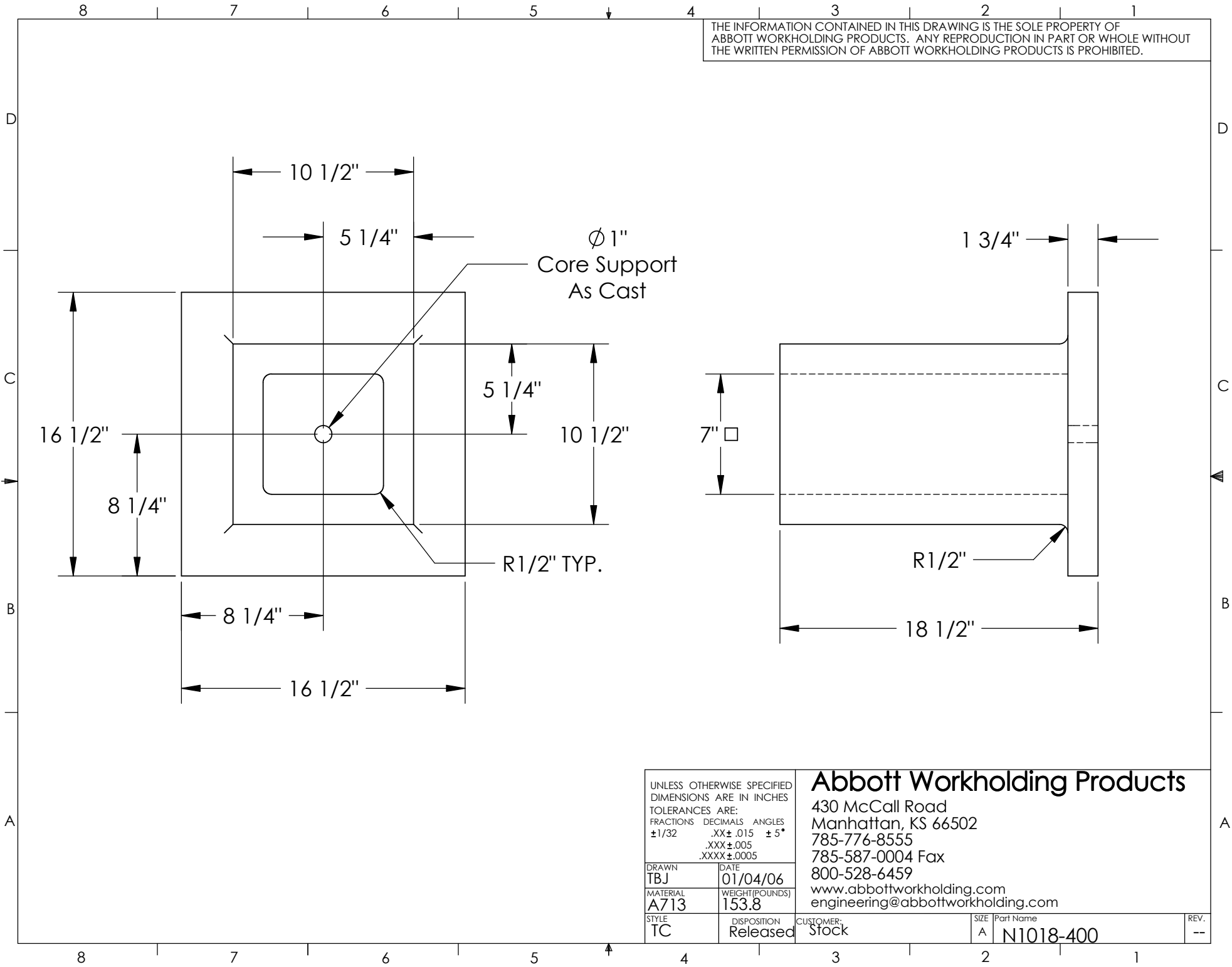

UNLESS OTHERWISE SPECIFIED DIMENSIONS ARE IN INCHES TOLERANCES ARE: FRACTIONS DECIMALS ANGLES ±1/32 .XX±.015 ±5° .XXX±.005 .XXXX±.0005	
DRAWN TBJ	DATE 01/04/06
MATERIAL A713	WEIGHT (POUNDS) 153.8
STYLE TC	DISPOSITION Released

Abbott Workholding Products
 430 McCall Road
 Manhattan, KS 66502
 785-776-8555
 785-587-0004 Fax
 800-528-6459
 www.abbottworkholding.com
 engineering@abbottworkholding.com

CUSTOMER: Stock	SIZE A	Part Name N1018-400	REV. --
--------------------	-----------	------------------------	------------