

5AP-MAZA-00245

This workholding package is designed for your MAZAK Variaxis 730-5X II (T-Slot) machining center.

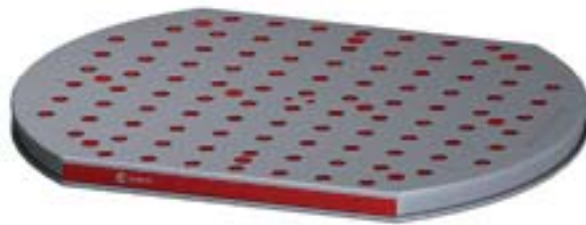

Notes

CHICK WORKHOLDING SOLUTIONS, INC
500 Keystone Drive • Warrendale, PA 15086 USA
Phone: (724) 772-1644 • Fax: (724) 772-1633
Toll Free: (800) 33-CHICK • (800) 332-4425
www.ChickWorkholding.com

5AP-MAZA-00245

This workholding package is designed for your MAZAK Variaxis 730-5X II (T-Slot) machining center.

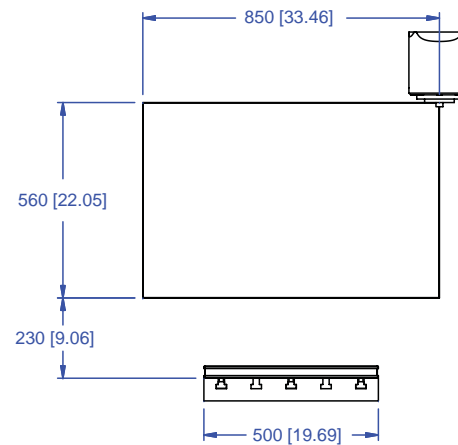
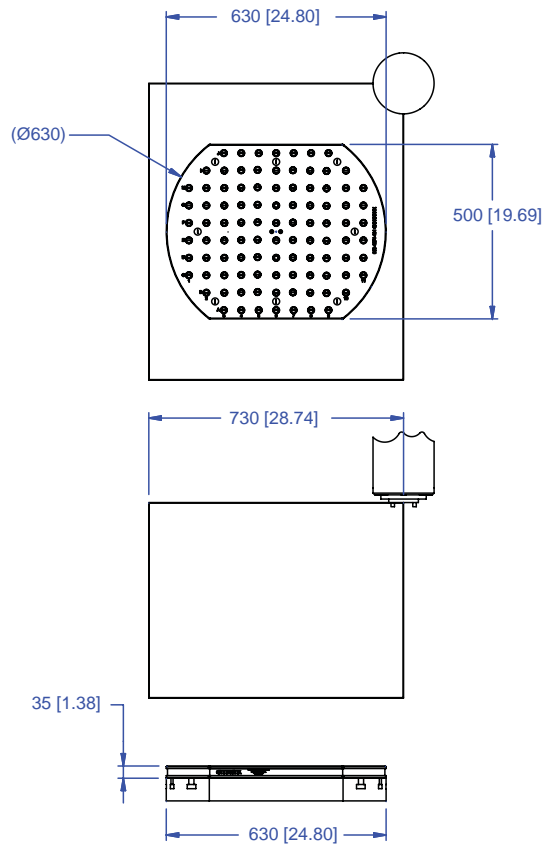

Notes

Machine travel may be limited by mechanical interference and/or machine safety zones. Please consult your machine's operating instructions for more information.

All dimensions are MM [IN]

CHICK WORKHOLDING SOLUTIONS, INC
 500 Keystone Drive • Warrendale, PA 15086 USA
 Phone: (724) 772-1644 • Fax: (724) 772-1633
 Toll Free: (800) 33-CHICK • (800) 332-4425
www.ChickWorkholding.com

5AP-MAZA-00245

This workholding package is designed for your MAZAK Variaxis 730-5X II (T-Slot) machining center.

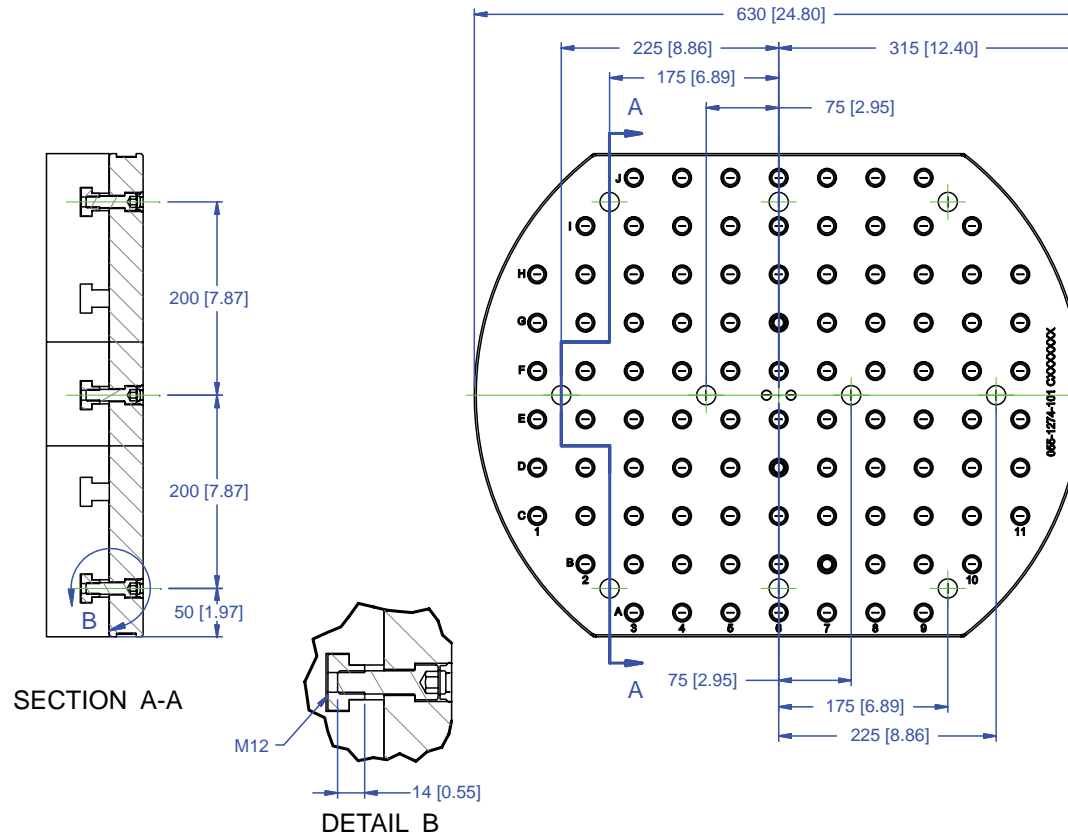

Notes

All dimensions are MM [IN]
 Maximum number of Qwik-Loks (5QL1040-AL 3 systems Max) (5QL1540-AL 5 systems Max).

CHICK WORKHOLDING SOLUTIONS, INC
 500 Keystone Drive • Warrendale, PA 15086 USA
 Phone: (724) 772-1644 • Fax: (724) 772-1633
 Toll Free: (800) 33-CHICK • (800) 332-4425
www.ChickWorkholding.com

5AP-MAZA-00245

This workholding package is designed for your MAZAK Variaxis 730-5X II (T-Slot) machining center.

FOUNDATION LENGTH, DEPTH, AND MOUNTING HOLE CONFIGURATION DESIGNED ACCORDING TO MACHINE TOOL SPECIFICATION



FOUNDATION MAT'L: CAST IRON
FOUNDATION INCLUDES INSTALLATION HARDWARE

DETAIL A

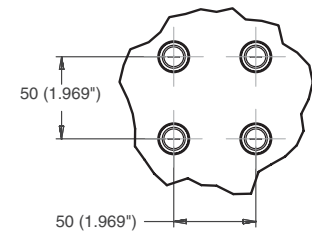

HOLE SPACING TOLERANCE
±0.02 TO 500mm
±0.03 TO 1200mm

SECTION B-B

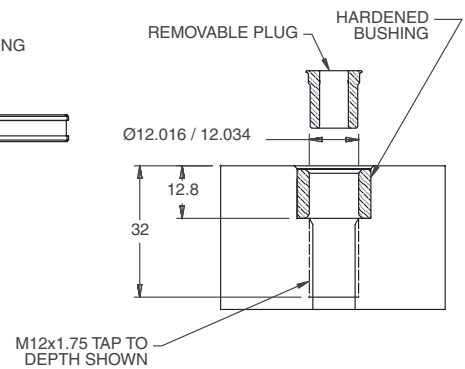

Notes
All dimensions are MM [IN]

CHICK WORKHOLDING SOLUTIONS, INC
500 Keystone Drive • Warrendale, PA 15086 USA
Phone: (724) 772-1644 • Fax: (724) 772-1633
Toll Free: (800) 33-CHICK • (800) 332-4425
www.ChickWorkholding.com