

5VP-DECK-00064

This workholding package is designed for your DECKEL MAHO DMC 104 V machining center.

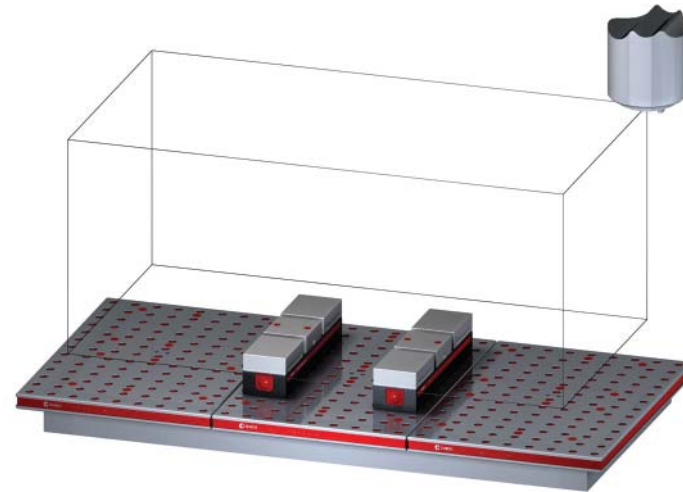

Notes

CHICK WORKHOLDING SOLUTIONS, INC
500 Keystone Drive • Warrendale, PA 15086 USA
Phone: (724) 772-1644 • Fax: (724) 772-1633
Toll Free: (800) 33-CHICK • (800) 332-4425
www.ChickWorkholding.com

5VP-DECK-00064

This workholding package is designed for your DECKEL MAHO DMC 104 V machining center.

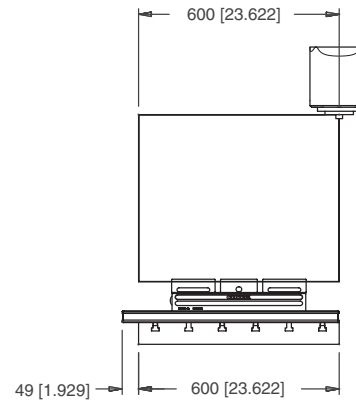
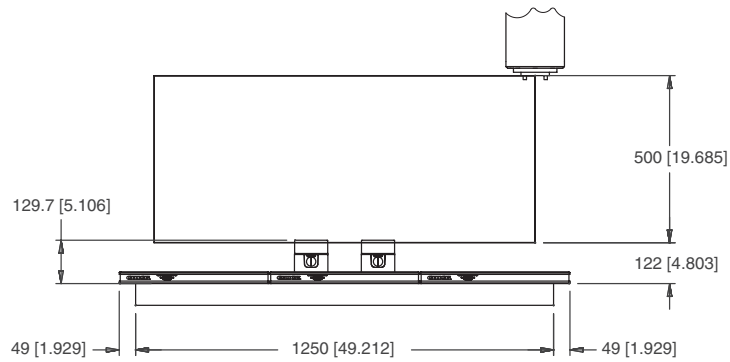
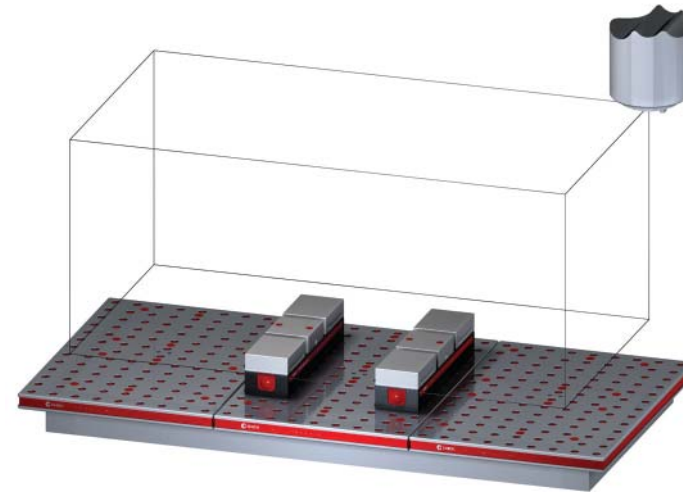
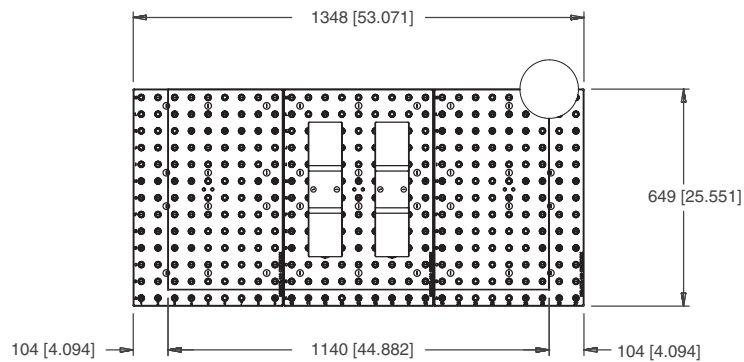

Notes

Machine travel may be limited by mechanical interference and/or machine safety zones. Please consult your machine's operating instructions for more information.

All dimensions are MM [IN]

CHICK WORKHOLDING SOLUTIONS, INC
 500 Keystone Drive • Warrendale, PA 15086 USA
 Phone: (724) 772-1644 • Fax: (724) 772-1633
 Toll Free: (800) 33-CHICK • (800) 332-4425
www.ChickWorkholding.com

5VP-DECK-00064

This workholding package is designed for your DECKEL MAHO DMC 104 V machining center.

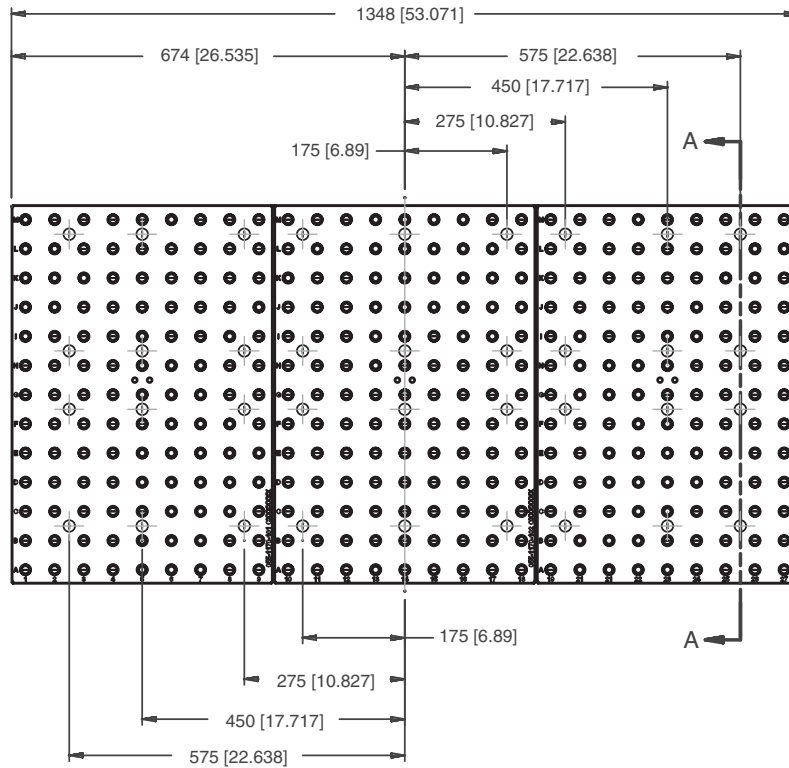

SECTION A-A

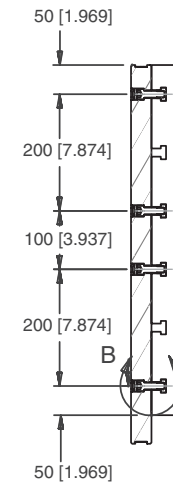

DETAIL B

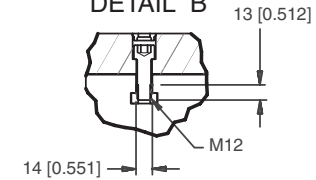

Notes
All dimensions are MM [IN]

CHICK WORKHOLDING SOLUTIONS, INC
500 Keystone Drive • Warrendale, PA 15086 USA
Phone: (724) 772-1644 • Fax: (724) 772-1633
Toll Free: (800) 33-CHICK • (800) 332-4425
www.ChickWorkholding.com

5VP-DECK-00064

This workholding package is designed for your DECKEL MAHO DMC 104 V machining center.

FOUNDATION LENGTH, DEPTH, AND MOUNTING HOLE CONFIGURATION DESIGNED ACCORDING TO MACHINE TOOL SPECIFICATION

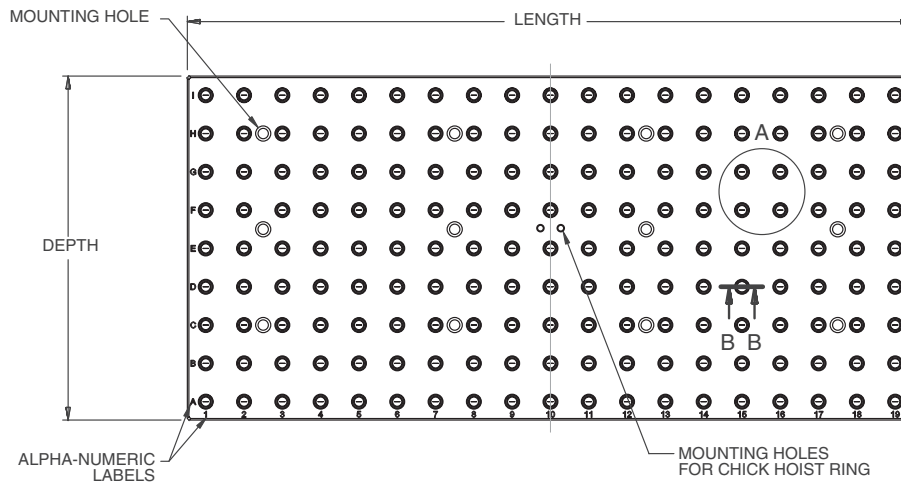

FOUNDATION MAT'L: CAST IRON
FOUNDATION INCLUDES INSTALLATION HARDWARE

DETAIL A

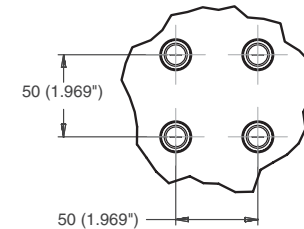

HOLE SPACING TOLERANCE
±0.02 TO 500mm
±0.03 TO 1200mm

SECTION B-B

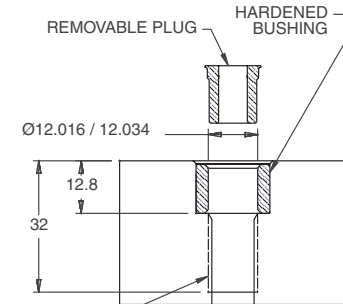

M12x1.75 TAP TO DEPTH SHOWN

Notes
All dimensions are MM [IN]

CHICK WORKHOLDING SOLUTIONS, INC
500 Keystone Drive • Warrendale, PA 15086 USA
Phone: (724) 772-1644 • Fax: (724) 772-1633
Toll Free: (800) 33-CHICK • (800) 332-4425
www.ChickWorkholding.com

One-Off Workholding

Jaw carriers broaden your modern workholding flexibility by offering vise-like fixturing.

Simply QwikChange™ the jaws and your modern workholding is ready for one-off workholding needs.



Notes

CHICK WORKHOLDING SOLUTIONS, INC
 500 Keystone Drive • Warrendale, PA 15086 USA
 Phone: (724) 772-1644 • Fax: (724) 772-1633
 Toll Free: (800) 33-CHICK • (800) 332-4425
www.ChickWorkholding.com

Batch Production

Machinable accessories are the optimal solution for batch production. They offer QwikChange™ and accurate repeat set ups to optimize the productivity of the machine center.

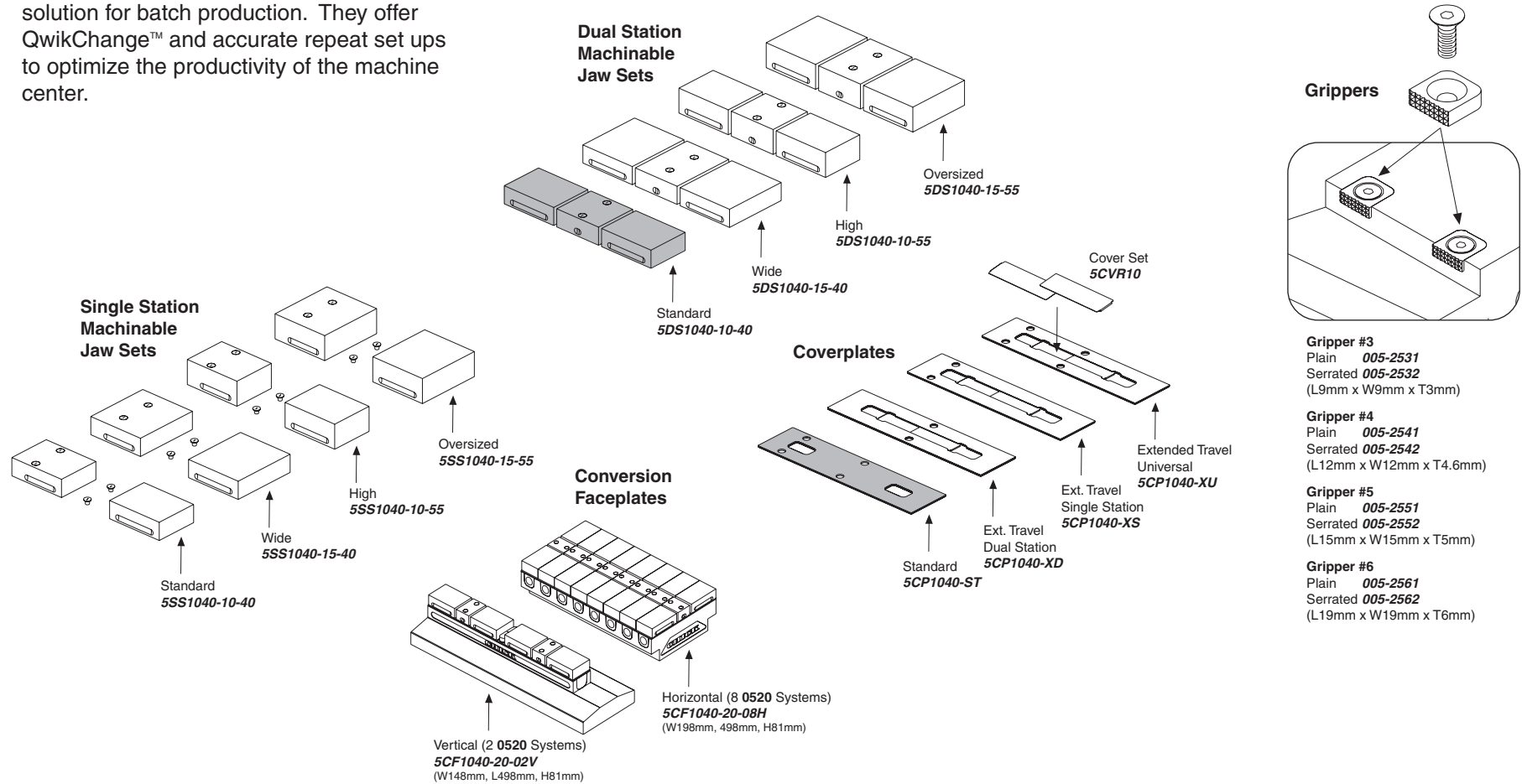

Notes
Grey item is included with a standard system

CHICK WORKHOLDING SOLUTIONS, INC
500 Keystone Drive • Warrendale, PA 15086 USA
Phone: (724) 772-1644 • Fax: (724) 772-1633
Toll Free: (800) 33-CHICK • (800) 332-4425
www.ChickWorkholding.com

Dedicated Fixturing

Machinable Faceplates provide QwikChange™ dedicated fixturing and are optimal for awkward or hard to hold parts. A mini pallet changer can be created by utilizing two Faceplates in tandem.



Notes

CHICK WORKHOLDING SOLUTIONS, INC
500 Keystone Drive • Warrendale, PA 15086 USA
Phone: (724) 772-1644 • Fax: (724) 772-1633
Toll Free: (800) 33-CHICK • (800) 332-4425
www.ChickWorkholding.com

QwikChange Machinable Dual Station Jaws



Individual Dual Station Jaws

Standard

- A** Moveable Jaw **5MJ1040-10-40**
(W99mm, H130mm, L40mm)
- B** Fixed Jaw **5FJ1040-10-40**
(W99mm, H110mm, L40mm)

Wide

- A** Moveable Jaw **5MJ1040-15-40**
(W148mm, H130mm, L40mm)
- B** Fixed Jaw **5FJ1040-15-40**
(W148mm, H110mm, L40mm)

High

- A** Moveable Jaw **5MJ1040-10-55**
(W99mm, H130mm, L55mm)
- B** Fixed Jaw **5FJ1040-10-55**
(W99mm, H110mm, L55mm)

Oversized

- A** Moveable Jaw **5MJ1040-15-55**
(W148mm, H130mm, L55mm)
- B** Fixed Jaw **5FJ1040-15-55**
(W148mm, H110mm, L55mm)

QwikChange Machinable Single Station Jaws

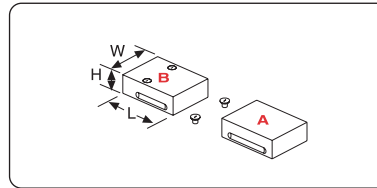

Individual Single Station Jaws

Standard

- A** Moveable Jaw **5MJ1040-10-40**
(W99mm, H130mm, L40mm)
- B** Fixed Jaw **5SJ1040-10-40**
(W99mm, H130mm, L40mm)

Wide

- A** Moveable Jaw **5MJ1040-15-40**
(W148mm, H130mm, L40mm)
- B** Fixed Jaw **5SJ1040-15-40**
(W148mm, H130mm, L40mm)

High

- A** Moveable Jaw **5MJ1040-10-55**
(W99mm, H130mm, L55mm)
- B** Fixed Jaw **5SJ1040-10-55**
(W99mm, H130mm, L55mm)

Oversized

- A** Moveable Jaw **5MJ1040-15-55**
(W148mm, H130mm, L55mm)
- B** Fixed Jaw **5SJ1040-15-55**
(W148mm, H130mm, L55mm)

QwikChange Jaw Carriers



Jaw Carriers (Inch)

- A** **5JC1040-FC-IN**
- B** **5JC1040-MC-IN**
- C** **5JC1040-SC-IN**
- D** **5JC1040-LM-IN**
- E** **5JC1040-SM-IN**

Jaw Carriers (Metric)

- A** **5JC1040-FC-MM**
- B** **5JC1040-MC-MM**
- C** **5JC1040-SC-MM**
- D** **5JC1040-LM-MM**
- E** **5JC1040-SM-MM**

- A** Dual Station Fixed
- B** Dual Station Moveable
- C** Single Station Fixed
- D** Single Station Long Moveable
- E** Single Station Short Moveable

Jaw Plates

- Standard (Set of 4)
JH4STD (Inch)
MJH10 (Metric)

HARD JAW PLATES

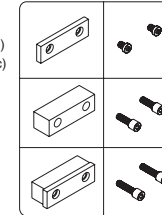

- Standard Mounting Screws: 3/8-16x1/2"
LHCS-375-050-008 (Inch)
LHCS-M08-016-008 (Metric)

- Thick (Set of 2)
JH4THK

- Thick Mounting Screws: 3/8-16x1"
SHCS-375-100-012

- Both Sizes
JH4STD &
JH4THK

- Both Sizes Mounting Screws: 3/8-16x1.25"
SHCS-375-125-008

- Standard (Set of 4)
JS4AL

SOFT JAW PLATES

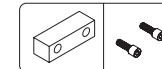

- Soft Mounting Screws: 3/8-16x1"
SHCS-375-100-012

Screws and Plugs

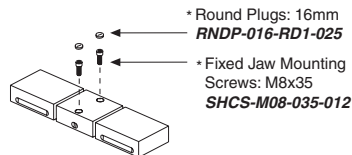

- * Round Plugs: 16mm
RNDP-016-RD1-025
- * Fixed Jaw Mounting Screws: M8x35
SHCS-M08-035-012

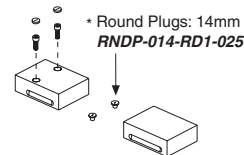

- * Round Plugs: 14mm
RNDP-014-RD1-025

Notes

Grey or * item is included with a standard system

CHICK WORKHOLDING SOLUTIONS, INC
500 Keystone Drive • Warrendale, PA 15086 USA
Phone: (724) 772-1644 • Fax: (724) 772-1633
Toll Free: (800) 33-CHICK • (800) 332-4425
www.ChickWorkholding.com

Dual Station



Single Station



Item Number	Description	A	B	C	D
5DS1040-10-40	Standard	99 [3.90]	40 [1.57]	34.5 [1.36]	14.5 [.57]
5DS1040-10-55	High	99 [3.90]	55 [2.17]	34.5 [1.36]	14.5 [.57]
5DS1040-15-40	Wide	148 [5.83]	40 [1.57]	59 [2.32]	39 [1.54]
5DS1040-15-55	Oversized	148 [5.83]	55 [2.17]	59 [2.32]	39 [1.54]

Item Number	Description	A	B	C	D
5SS1040-10-40	Standard	99 [3.90]	40 [1.57]	29.5 [1.16]	14.5 [.57]
5SS1040-10-55	High	99 [3.90]	55 [2.17]	29.5 [1.16]	14.5 [.57]
5SS1040-15-40	Wide	148 [5.83]	40 [1.57]	54 [2.13]	39 [1.54]
5SS1040-15-55	Oversized	148 [5.83]	55 [2.17]	54 [2.13]	39 [1.54]

Notes

Grey area indicates no cut zone
 All dimensions are MM [IN]
 Dimensions centered on the "A" dimension.

CHICK WORKHOLDING SOLUTIONS, INC
 500 Keystone Drive • Warrendale, PA 15086 USA
 Phone: (724) 772-1644 • Fax: (724) 772-1633
 Toll Free: (800) 33-CHICK • (800) 332-4425
www.ChickWorkholding.com

Dual Station



Item Number	Description	A	Jaw Width
5DS1040-10-40	Standard	26 [1.02]	99 [3.90]
5DS1040-10-55	High	41 [1.61]	99 [3.90]
5DS1040-15-40	Wide	26 [1.02]	148 [5.83]
5DS1040-15-55	Oversized	41 [1.61]	148 [5.83]

Single Station



Item Number	Description	A	Jaw Width
5SS1040-10-40	Standard	26 [1.02]	99 [3.90]
5SS1040-10-55	High	41 [1.61]	99 [3.90]
5SS1040-15-40	Wide	26 [1.02]	148 [5.83]
5SS1040-15-55	Oversized	41 [1.61]	148 [5.83]

Notes

All dimensions are MM [IN]
 Additional closure is available with an Extended Travel Coverplate.
 Contact CHICK for details.

CHICK WORKHOLDING SOLUTIONS, INC
 500 Keystone Drive • Warrendale, PA 15086 USA
 Phone: (724) 772-1644 • Fax: (724) 772-1633
 Toll Free: (800) 33-CHICK • (800) 332-4425
www.ChickWorkholding.com



MOUNTING

Foundation

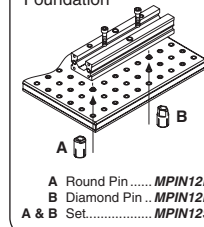

T-Slotted Table

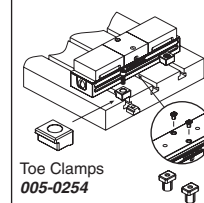

Bolt and T-Nut supplied by customer

Bottom of Base

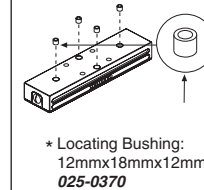

Locating Keys	
Inch Size	
MKE500	(1/2")
MKE562	(9/16")
MKE625	(5/8")
MKE688	(11/16")
MKE750	(3/4")
MKE812	(13/16")
Metric Size	
MKE10	(10mm)
MKE12	(12mm)
MKE14X18	(14mm)
MKE16	(16mm)
MKE20	(20mm)

Notes

Grey items are included with a standard system
 For QwikChange™ Jaw accessories, see pages 5-8

CHICK WORKHOLDING SOLUTIONS, INC
 500 Keystone Drive • Warrendale, PA 15086 USA
 Phone: (724) 772-1644 • Fax: (724) 772-1633
 Toll Free: (800) 33-CHICK • (800) 332-4425
www.ChickWorkholding.com



Notes

Grey items are included with a standard system

CHICK WORKHOLDING SOLUTIONS, INC
 500 Keystone Drive • Warrendale, PA 15086 USA
 Phone: (724) 772-1644 • Fax: (724) 772-1633
 Toll Free: (800) 33-CHICK • (800) 332-4425
www.ChickWorkholding.com

Pounds (lbs)

Force	=	Torque	X	Slope
lbs	=	in-lb	x	8.0
lbs	=	ft-lbs	x	96

Torque (ft-lb)	Force (lbs)
0	0
10	962
20	1923
30	2885
40	3846
50	4808
52	5000



Note: ◆ Maximum Recommended Torque. Actual results may vary.

Kilonewtons (kN)

Force	=	Torque	X	Slope
N	=	N-m	x	315
kN	=	N-m	x	0.315

Torque (N-m)	Force (kN)
0	0.0
10	3.1
20	6.3
30	9.4
40	12.6
50	15.7
60	18.9
65	20.5
70	22.0

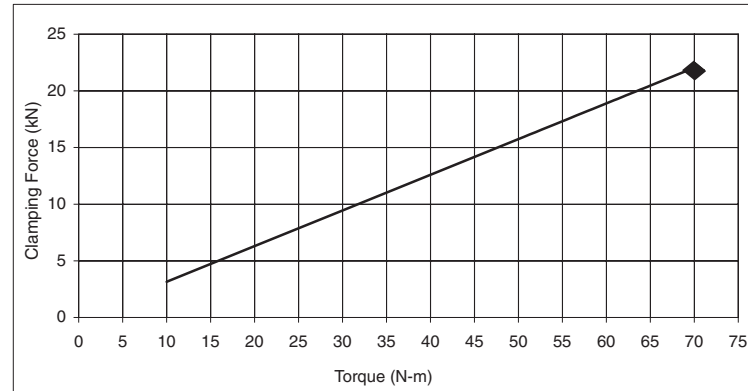

Note: ◆ Maximum Recommended Torque. Actual results may vary.

Notes

CHICK WORKHOLDING SOLUTIONS, INC
 500 Keystone Drive • Warrendale, PA 15086 USA
 Phone: (724) 772-1644 • Fax: (724) 772-1633
 Toll Free: (800) 33-CHICK • (800) 332-4425
www.ChickWorkholding.com