

5VP-HAAS-00192

This workholding package is designed for your HAAS VF-2 machining center.

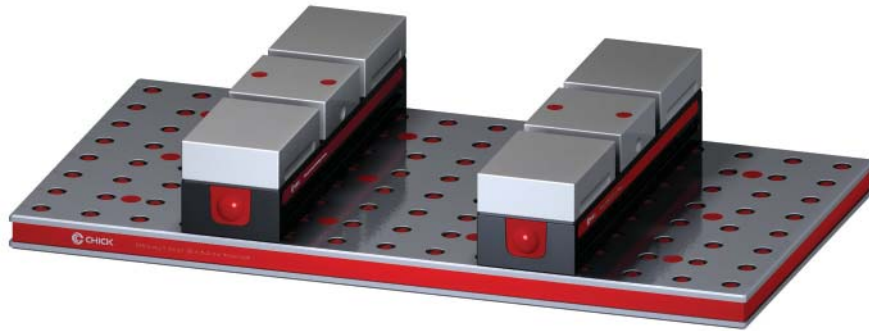

Workholding package

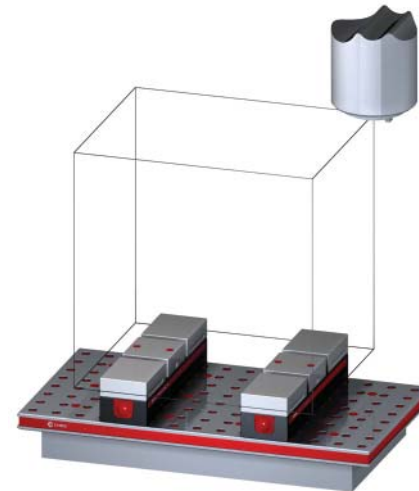

Workholding package
in machine envelope

Notes

CHICK WORKHOLDING SOLUTIONS, INC.
500 Keystone Drive • Warrendale, PA 15086 USA
Phone: (724) 772-1644 • Fax: (724) 772-1633
www.ChickWorkholding.com

5VP-HAAS-00192

This workholding package is designed for your HAAS VF-2 machining center.

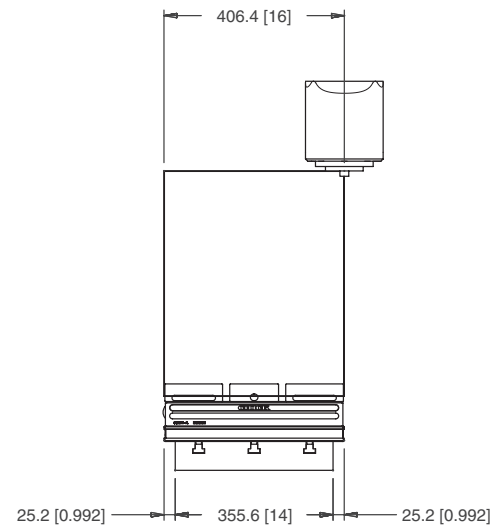
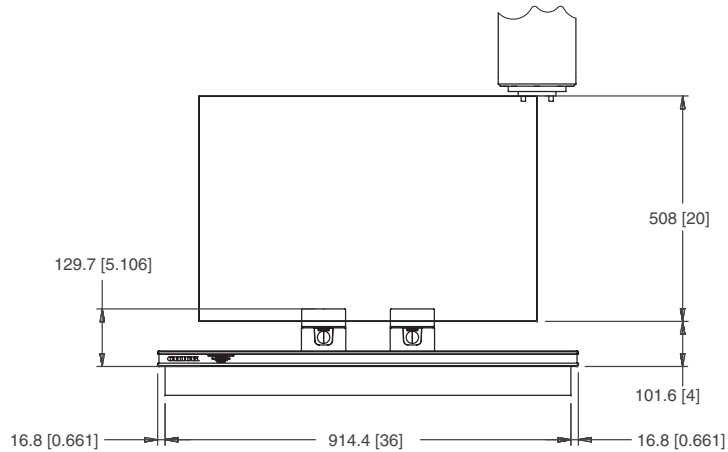
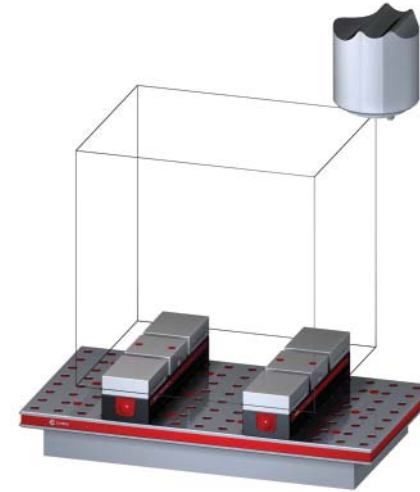
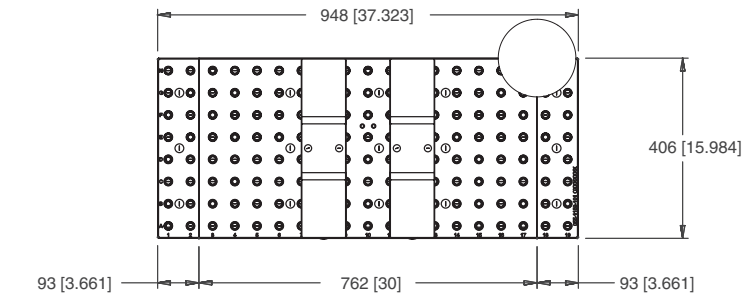

Notes

Machine travel may be limited by mechanical interference and/or machine safety zones. Please consult your machine's operating instructions for more information.

All dimensions are MM [IN]

CHICK WORKHOLDING SOLUTIONS, INC.
 500 Keystone Drive • Warrendale, PA 15086 USA
 Phone: (724) 772-1644 • Fax: (724) 772-1633
www.ChickWorkholding.com

5VP-HAAS-00192

This workholding package is designed for your HAAS VF-2 machining center.

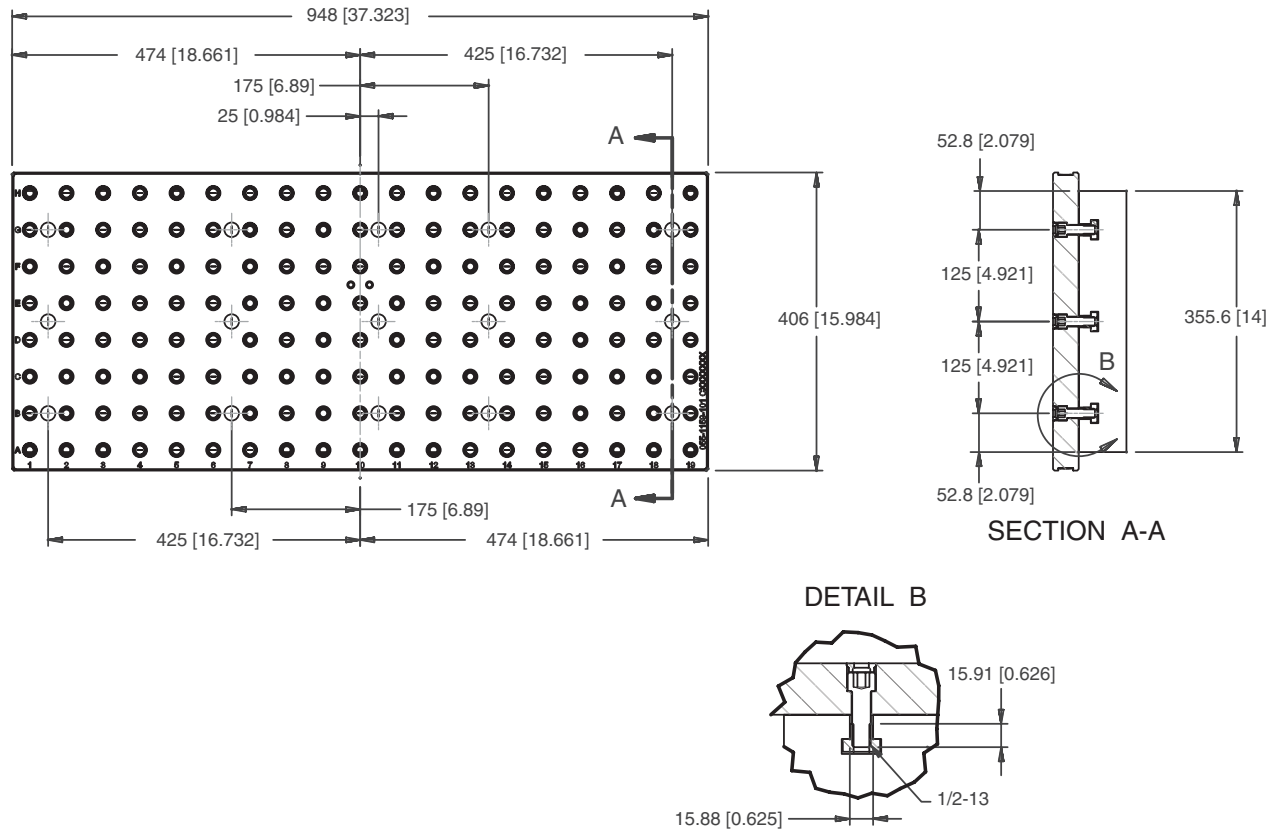

Notes
All dimensions are MM [IN]

CHICK WORKHOLDING SOLUTIONS, INC.
500 Keystone Drive • Warrendale, PA 15086 USA
Phone: (724) 772-1644 • Fax: (724) 772-1633
www.ChickWorkholding.com

5VP-HAAS-00192

This workholding package is designed for your HAAS VF-2 machining center.

FOUNDATION LENGTH, DEPTH, AND MOUNTING HOLE CONFIGURATION DESIGNED ACCORDING TO MACHINE TOOL SPECIFICATION

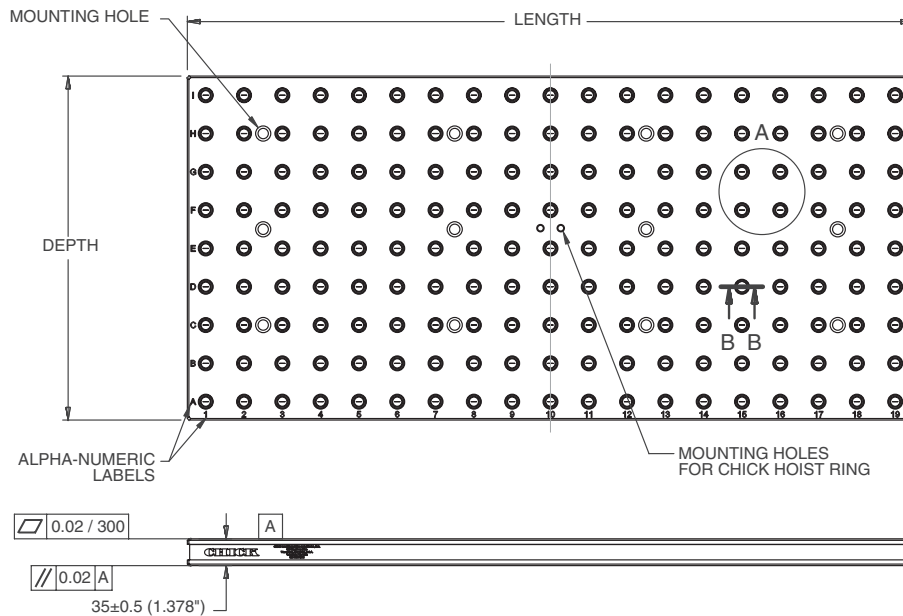

FOUNDATION MAT'L: CAST IRON
FOUNDATION INCLUDES INSTALLATION HARDWARE

DETAIL A

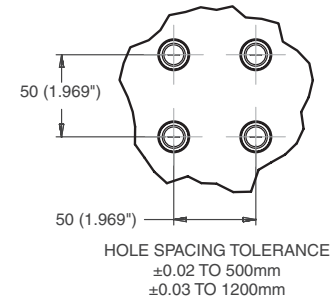

SECTION B-B

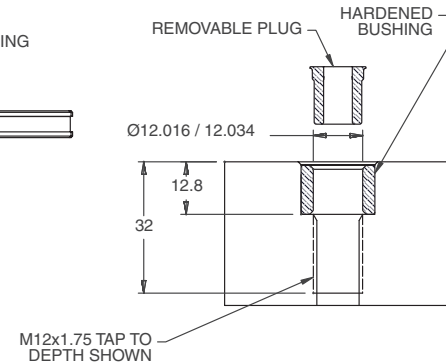

Notes
All dimensions are MM [IN]

CHICK WORKHOLDING SOLUTIONS, INC.
500 Keystone Drive • Warrendale, PA 15086 USA
Phone: (724) 772-1644 • Fax: (724) 772-1633
www.ChickWorkholding.com

One-Off Workholding

Jaw carriers broaden your modern workholding flexibility by offering vise-like fixturing.

Simply QwikChange™ the jaws and your modern workholding is ready for one-off workholding needs.



Notes

CHICK WORKHOLDING SOLUTIONS, INC.
 500 Keystone Drive • Warrendale, PA 15086 USA
 Phone: (724) 772-1644 • Fax: (724) 772-1633
www.ChickWorkholding.com

Batch Production

Machinable accessories are the optimal solution for batch production. They offer QwikChange™ and accurate repeat set ups to optimize the productivity of the machine center.

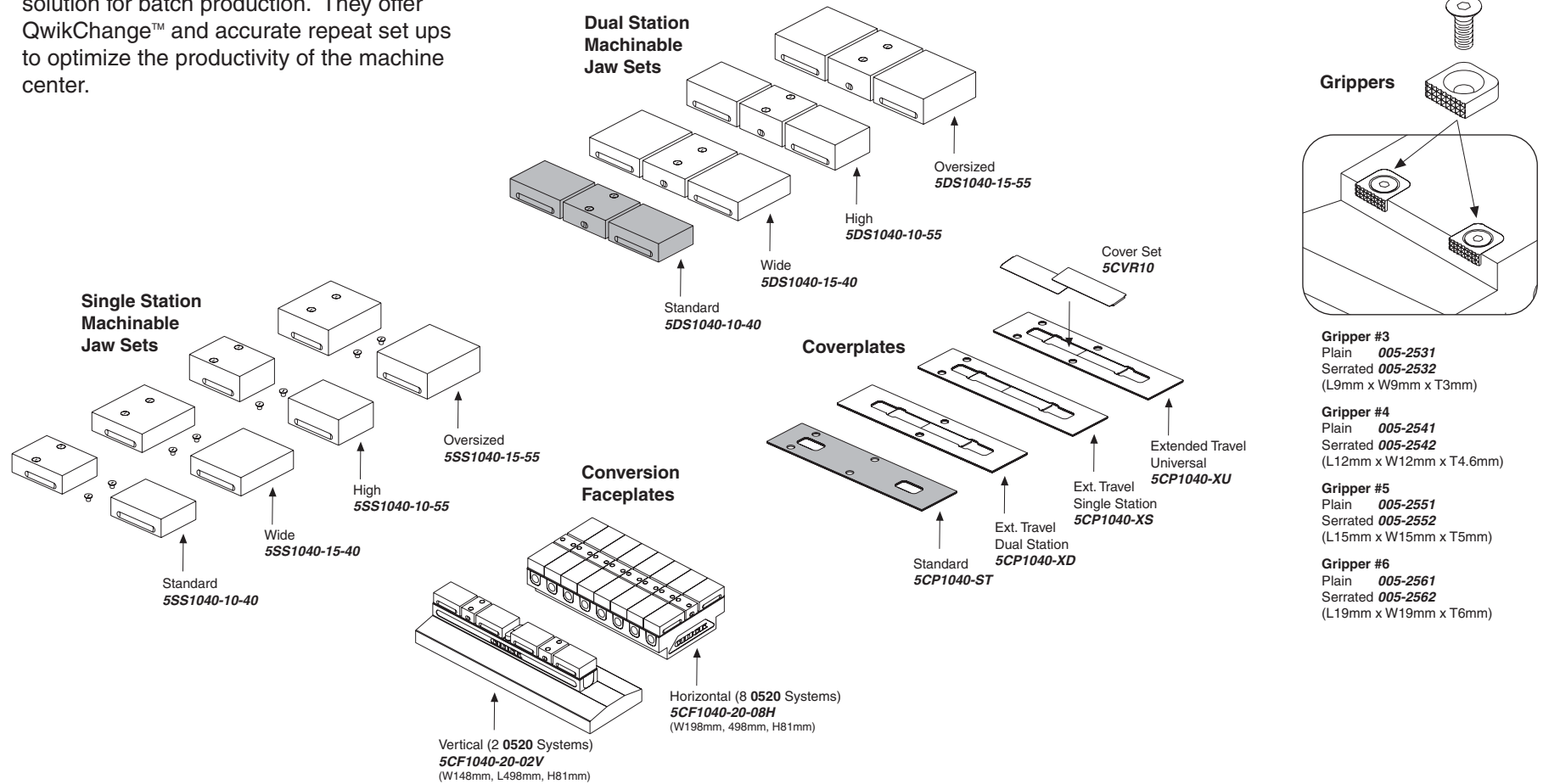

Notes

Grey item is included with a standard system

CHICK WORKHOLDING SOLUTIONS, INC.
 500 Keystone Drive • Warrendale, PA 15086 USA
 Phone: (724) 772-1644 • Fax: (724) 772-1633
www.ChickWorkholding.com

Dedicated Fixturing

Machinable Faceplates provide QwikChange™ dedicated fixturing and are optimal for awkward or hard to hold parts. A mini pallet changer can be created by utilizing two Faceplates in tandem.



Notes

CHICK WORKHOLDING SOLUTIONS, INC.
500 Keystone Drive • Warrendale, PA 15086 USA
Phone: (724) 772-1644 • Fax: (724) 772-1633
www.ChickWorkholding.com

QwikChange Machinable Dual Station Jaws

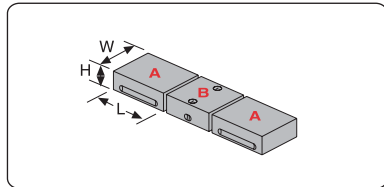

Individual Dual Station Jaws

Standard

- A** Moveable Jaw **5MJ1040-10-40**
(W99mm, H130mm, L40mm)
- B** Fixed Jaw **5FJ1040-10-40**
(W99mm, H110mm, L40mm)

Wide

- A** Moveable Jaw **5MJ1040-15-40**
(W148mm, H130mm, L40mm)
- B** Fixed Jaw **5FJ1040-15-40**
(W148mm, H110mm, L40mm)

High

- A** Moveable Jaw **5MJ1040-10-55**
(W99mm, H130mm, L55mm)
- B** Fixed Jaw **5FJ1040-10-55**
(W99mm, H110mm, L55mm)

Oversized

- A** Moveable Jaw **5MJ1040-15-55**
(W148mm, H130mm, L55mm)
- B** Fixed Jaw **5FJ1040-15-55**
(W148mm, H110mm, L55mm)

QwikChange Machinable Single Station Jaws

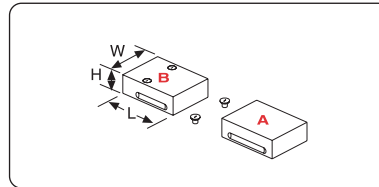

Individual Single Station Jaws

Standard

- A** Moveable Jaw **5MJ1040-10-40**
(W99mm, H130mm, L40mm)
- B** Fixed Jaw **5SJ1040-10-40**
(W99mm, H130mm, L40mm)

Wide

- A** Moveable Jaw **5MJ1040-15-40**
(W148mm, H130mm, L40mm)
- B** Fixed Jaw **5SJ1040-15-40**
(W148mm, H130mm, L40mm)

High

- A** Moveable Jaw **5MJ1040-10-55**
(W99mm, H130mm, L55mm)
- B** Fixed Jaw **5SJ1040-10-55**
(W99mm, H130mm, L55mm)

Oversized

- A** Moveable Jaw **5MJ1040-15-55**
(W148mm, H130mm, L55mm)
- B** Fixed Jaw **5SJ1040-15-55**
(W148mm, H130mm, L55mm)

QwikChange Jaw Carriers

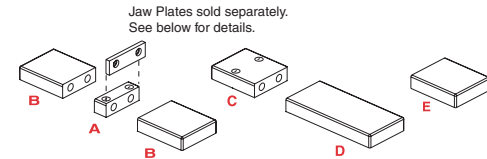

Jaw Carriers (Inch)

- A** **5JC1040-FC-IN**
- B** **5JC1040-MC-IN**
- C** **5JC1040-SC-IN**
- D** **5JC1040-LM-IN**
- E** **5JC1040-SM-IN**

Jaw Carriers (Metric)

- A** **5JC1040-FC-MM**
- B** **5JC1040-MC-MM**
- C** **5JC1040-SC-MM**
- D** **5JC1040-LM-MM**
- E** **5JC1040-SM-MM**

- A** Dual Station Fixed
- B** Dual Station Moveable

- C** Single Station Fixed
- D** Single Station Long Moveable

- E** Single Station Short Moveable

Jaw Plates

HARD JAW PLATES

- Standard (Set of 4)
JH4STD (Inch)
MJH10 (Metric)

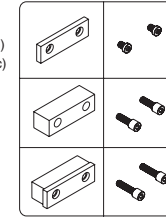

- Thick (Set of 2)
JH4THK

- Both Sizes
JH4STD &
JH4THK

- Standard Mounting Screws: 3/8-16x1/2"
LHCS-375-050-008 (Inch)
LHCS-M08-016-008 (Metric)

- Thick Mounting Screws: 3/8-16x1"
SHCS-375-100-012

- Both Sizes Mounting Screws: 3/8-16x1.25"
SHCS-375-125-008

SOFT JAW PLATES

- Standard (Set of 4)
JS4AL

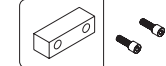

- Soft Mounting Screws: 3/8-16x1"
SHCS-375-100-012

Screws and Plugs

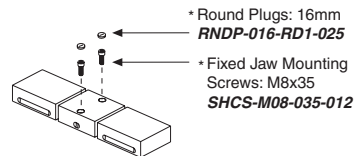

- * Round Plugs: 16mm
RNDP-016-RD1-025
- * Fixed Jaw Mounting Screws: M8x35
SHCS-M08-035-012

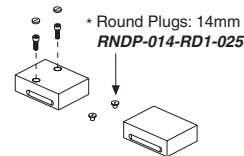

- * Round Plugs: 14mm
RNDP-014-RD1-025

Notes

Grey or * item is included with a standard system

CHICK WORKHOLDING SOLUTIONS, INC.
500 Keystone Drive • Warrendale, PA 15086 USA
Phone: (724) 772-1644 • Fax: (724) 772-1633
www.ChickWorkholding.com

Dual Station



Single Station



| Item Number | Description | A | B | C | D |
|----------------------|-------------|------------|-----------|-------------|------------|
| 5DS1040-10-40 | Standard | 99 [3.90] | 40 [1.57] | 34.5 [1.36] | 14.5 [.57] |
| 5DS1040-10-55 | High | 99 [3.90] | 55 [2.17] | 34.5 [1.36] | 14.5 [.57] |
| 5DS1040-15-40 | Wide | 148 [5.83] | 40 [1.57] | 59 [2.32] | 39 [1.54] |
| 5DS1040-15-55 | Oversized | 148 [5.83] | 55 [2.17] | 59 [2.32] | 39 [1.54] |

| Item Number | Description | A | B | C | D |
|----------------------|-------------|------------|-----------|-------------|------------|
| 5SS1040-10-40 | Standard | 99 [3.90] | 40 [1.57] | 29.5 [1.16] | 14.5 [.57] |
| 5SS1040-10-55 | High | 99 [3.90] | 55 [2.17] | 29.5 [1.16] | 14.5 [.57] |
| 5SS1040-15-40 | Wide | 148 [5.83] | 40 [1.57] | 54 [2.13] | 39 [1.54] |
| 5SS1040-15-55 | Oversized | 148 [5.83] | 55 [2.17] | 54 [2.13] | 39 [1.54] |

Notes

Grey area indicates no cut zone
 All dimensions are MM [IN]
 Dimensions centered on the "A" dimension.

CHICK WORKHOLDING SOLUTIONS, INC.
 500 Keystone Drive • Warrendale, PA 15086 USA
 Phone: (724) 772-1644 • Fax: (724) 772-1633
www.ChickWorkholding.com

Dual Station



| Item Number | Description | A | Jaw Width |
|----------------------|-------------|-----------|------------|
| 5DS1040-10-40 | Standard | 26 [1.02] | 99 [3.90] |
| 5DS1040-10-55 | High | 41 [1.61] | 99 [3.90] |
| 5DS1040-15-40 | Wide | 26 [1.02] | 148 [5.83] |
| 5DS1040-15-55 | Oversized | 41 [1.61] | 148 [5.83] |

Single Station



| Item Number | Description | A | Jaw Width |
|----------------------|-------------|-----------|------------|
| 5SS1040-10-40 | Standard | 26 [1.02] | 99 [3.90] |
| 5SS1040-10-55 | High | 41 [1.61] | 99 [3.90] |
| 5SS1040-15-40 | Wide | 26 [1.02] | 148 [5.83] |
| 5SS1040-15-55 | Oversized | 41 [1.61] | 148 [5.83] |

Notes

All dimensions are MM [IN]
 Additional closure is available with an Extended Travel Coverplate.
 Contact CHICK for details.

CHICK WORKHOLDING SOLUTIONS, INC.
 500 Keystone Drive • Warrendale, PA 15086 USA
 Phone: (724) 772-1644 • Fax: (724) 772-1633
www.ChickWorkholding.com



MOUNTING

Foundation



T-Slotted Table



Bolt and T-Nut
supplied by customer

Bottom of Base



Locating Keys

| Inch Size |
|-----------------|
| MKE500 (1/2") |
| MKE562 (9/16") |
| MKE625 (5/8") |
| MKE688 (11/16") |
| MKE750 (3/4") |
| MKE812 (13/16") |
| |
| Metric Size |
| MKE10 (10mm) |
| MKE12 (12mm) |
| MKE14X18 (14mm) |
| MKE16 (16mm) |
| MKE20 (20mm) |

Notes

Grey items are included with a standard system
 For QwikChange™ Jaw accessories, see pages 5-8

CHICK WORKHOLDING SOLUTIONS, INC.
 500 Keystone Drive • Warrendale, PA 15086 USA
 Phone: (724) 772-1644 • Fax: (724) 772-1633
 www.ChickWorkholding.com

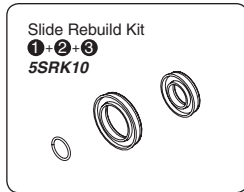
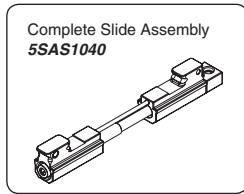

Notes

Grey items are included with a standard system

CHICK WORKHOLDING SOLUTIONS, INC.
 500 Keystone Drive • Warrendale, PA 15086 USA
 Phone: (724) 772-1644 • Fax: (724) 772-1633
www.ChickWorkholding.com

Pounds (lbs)

| | | | | |
|-------|---|--------|---|-------|
| Force | = | Torque | X | Slope |
| lbs | = | in-lb | x | 8.0 |
| lbs | = | ft-lbs | x | 96 |

| Torque (ft-lb) | Force (lbs) |
|----------------|-------------|
| 0 | 0 |
| 10 | 962 |
| 20 | 1923 |
| 30 | 2885 |
| 40 | 3846 |
| 50 | 4808 |
| 52 | 5000 |

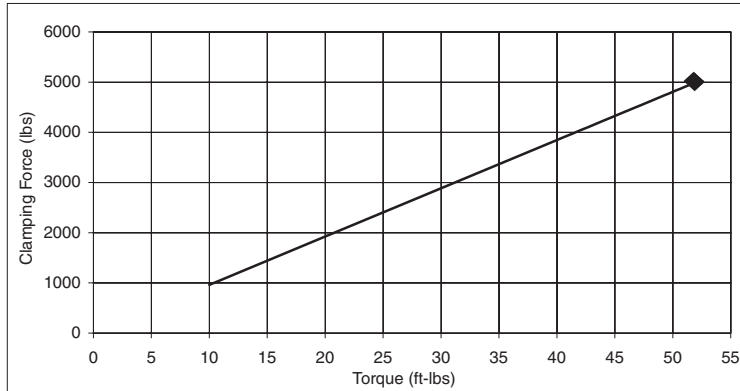

Note: ◆ Maximum Recommended Torque. Actual results may vary.

Kilonewtons (kN)

| | | | | |
|-------|---|--------|---|-------|
| Force | = | Torque | X | Slope |
| N | = | N-m | x | 315 |
| kN | = | N-m | x | 0.315 |

| Torque (N-m) | Force (kN) |
|--------------|------------|
| 0 | 0.0 |
| 10 | 3.1 |
| 20 | 6.3 |
| 30 | 9.4 |
| 40 | 12.6 |
| 50 | 15.7 |
| 60 | 18.9 |
| 65 | 20.5 |
| 70 | 22.0 |

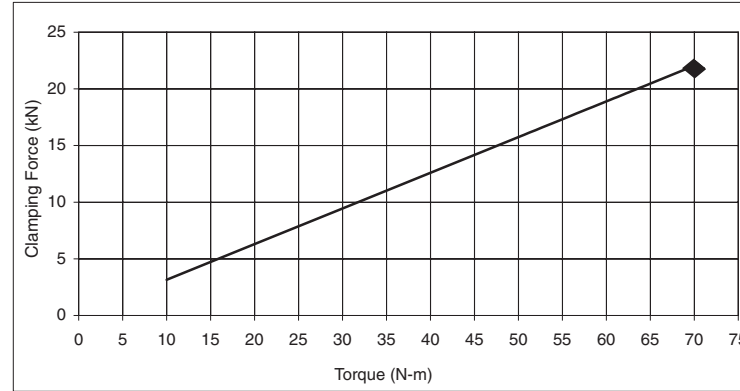

Note: ◆ Maximum Recommended Torque. Actual results may vary.

Notes

CHICK WORKHOLDING SOLUTIONS, INC.
 500 Keystone Drive • Warrendale, PA 15086 USA
 Phone: (724) 772-1644 • Fax: (724) 772-1633
www.ChickWorkholding.com