

5VP-HAAS-00196

This workholding package is designed for your HAAS VF-2 machining center.

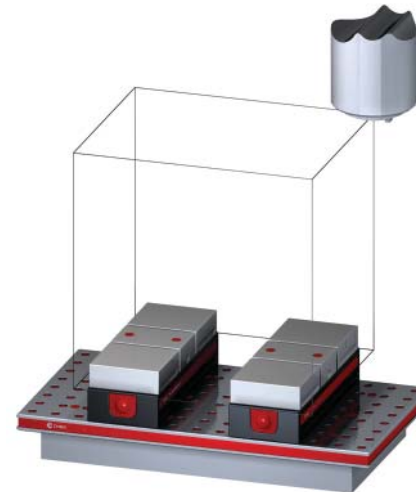

Workholding package



Workholding package
in machine envelope

Notes

CHICK WORKHOLDING SOLUTIONS, INC.
500 Keystone Drive • Warrendale, PA 15086 USA
Phone: (724) 772-1644 • Fax: (724) 772-1633
www.ChickWorkholding.com

5VP-HAAS-00196

This workholding package is designed for your HAAS VF-2 machining center.

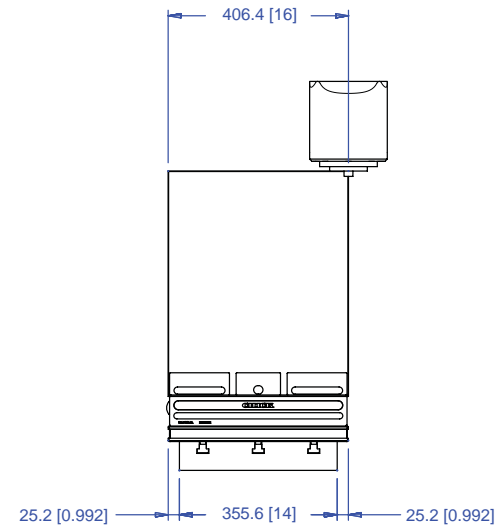
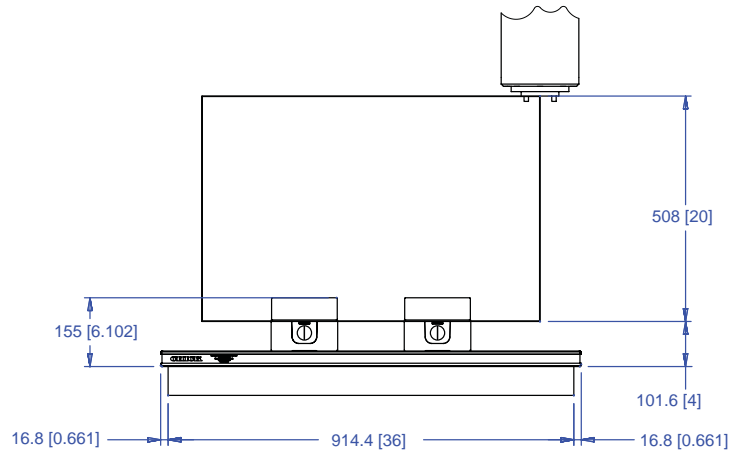
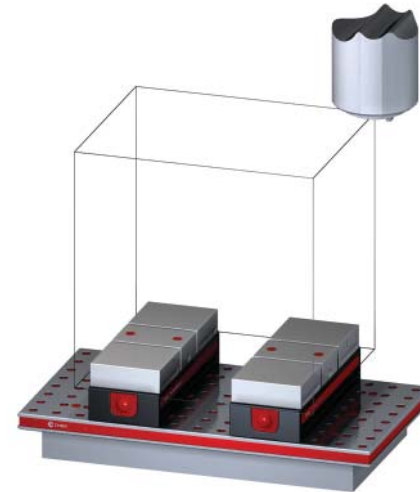
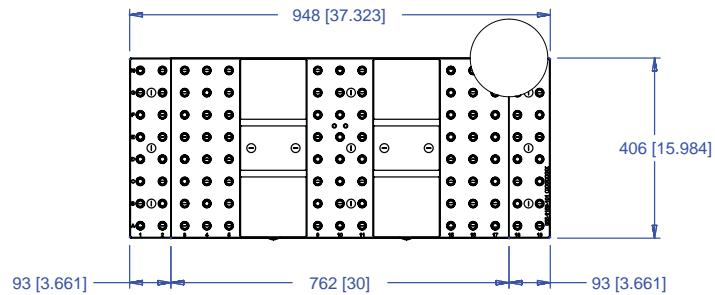

Notes

Machine travel may be limited by mechanical interference and/or machine safety zones. Please consult your machine's operating instructions for more information.

All dimensions are MM [IN]

CHICK WORKHOLDING SOLUTIONS, INC.
 500 Keystone Drive • Warrendale, PA 15086 USA
 Phone: (724) 772-1644 • Fax: (724) 772-1633
www.ChickWorkholding.com

5VP-HAAS-00196

This workholding package is designed for your HAAS VF-2 machining center.

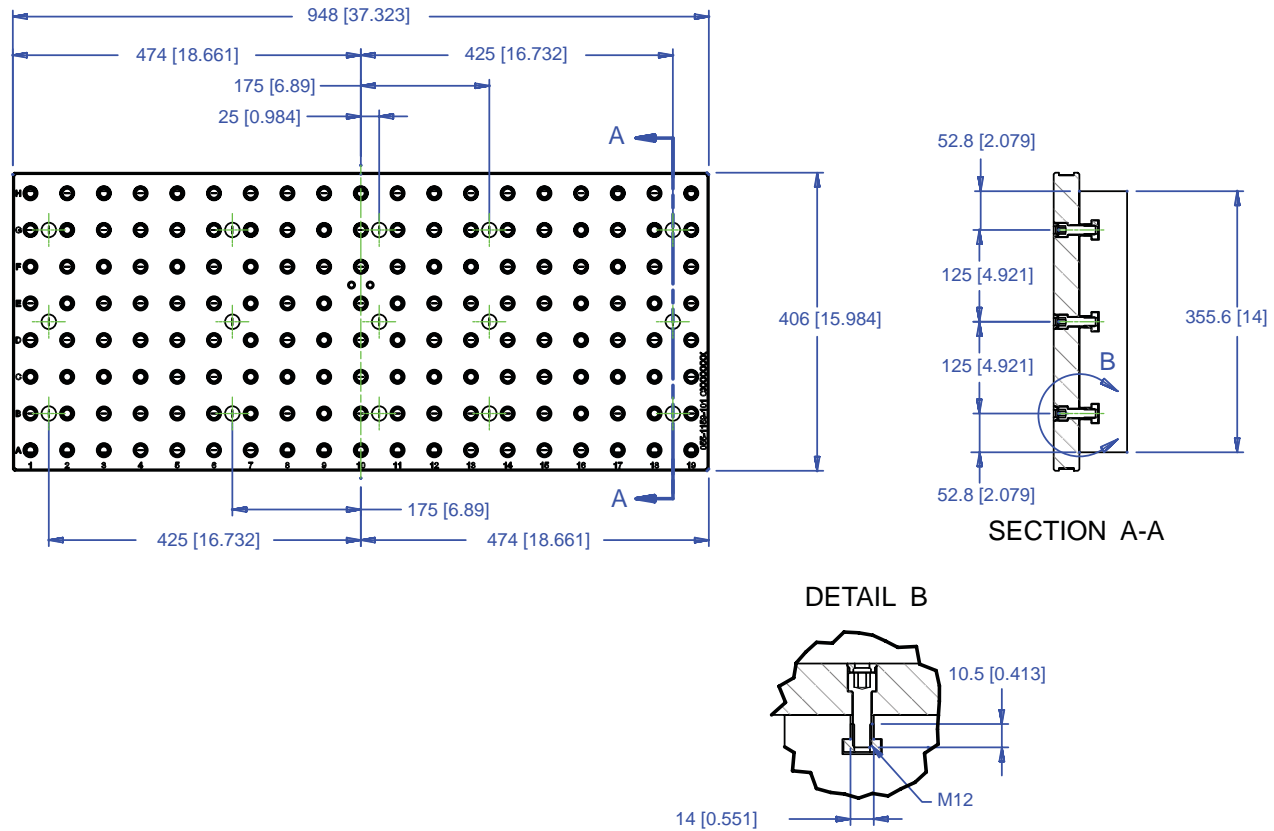

Notes
All dimensions are MM [IN]

CHICK WORKHOLDING SOLUTIONS, INC.
500 Keystone Drive • Warrendale, PA 15086 USA
Phone: (724) 772-1644 • Fax: (724) 772-1633
www.ChickWorkholding.com

5VP-HAAS-00196

This workholding package is designed for your HAAS VF-2 machining center.

FOUNDATION LENGTH, DEPTH, AND MOUNTING HOLE CONFIGURATION DESIGNED ACCORDING TO MACHINE TOOL SPECIFICATION

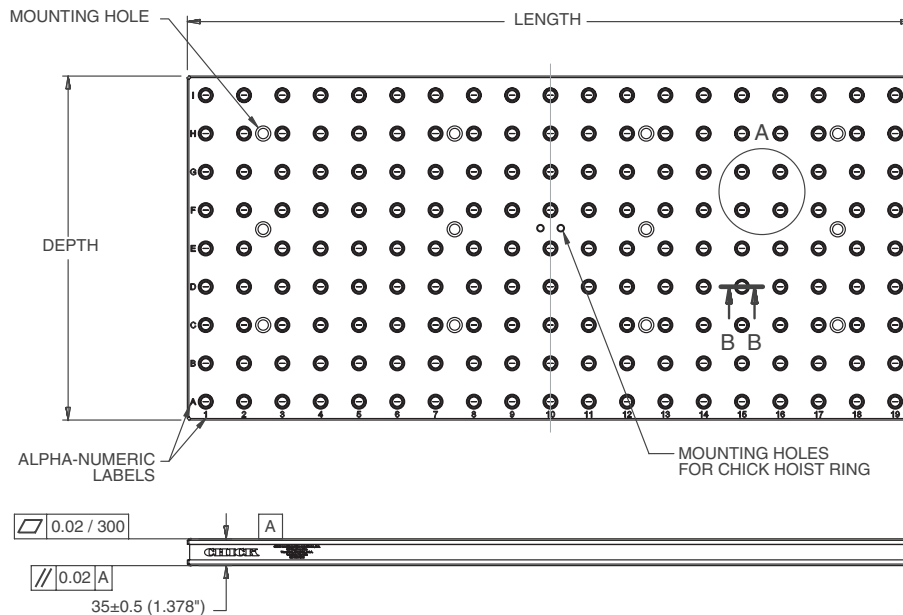

FOUNDATION MAT'L: CAST IRON
FOUNDATION INCLUDES INSTALLATION HARDWARE

DETAIL A

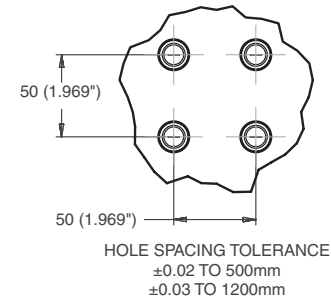

SECTION B-B

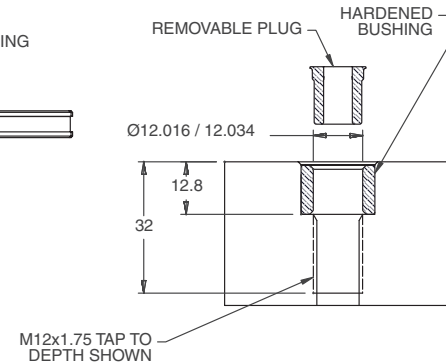

Notes
All dimensions are MM [IN]

CHICK WORKHOLDING SOLUTIONS, INC.
500 Keystone Drive • Warrendale, PA 15086 USA
Phone: (724) 772-1644 • Fax: (724) 772-1633
www.ChickWorkholding.com

Batch Production

Machinable accessories are the optimal solution for batch production. They offer QwikChange™ and accurate repeat set ups to optimize the productivity of the machine center.

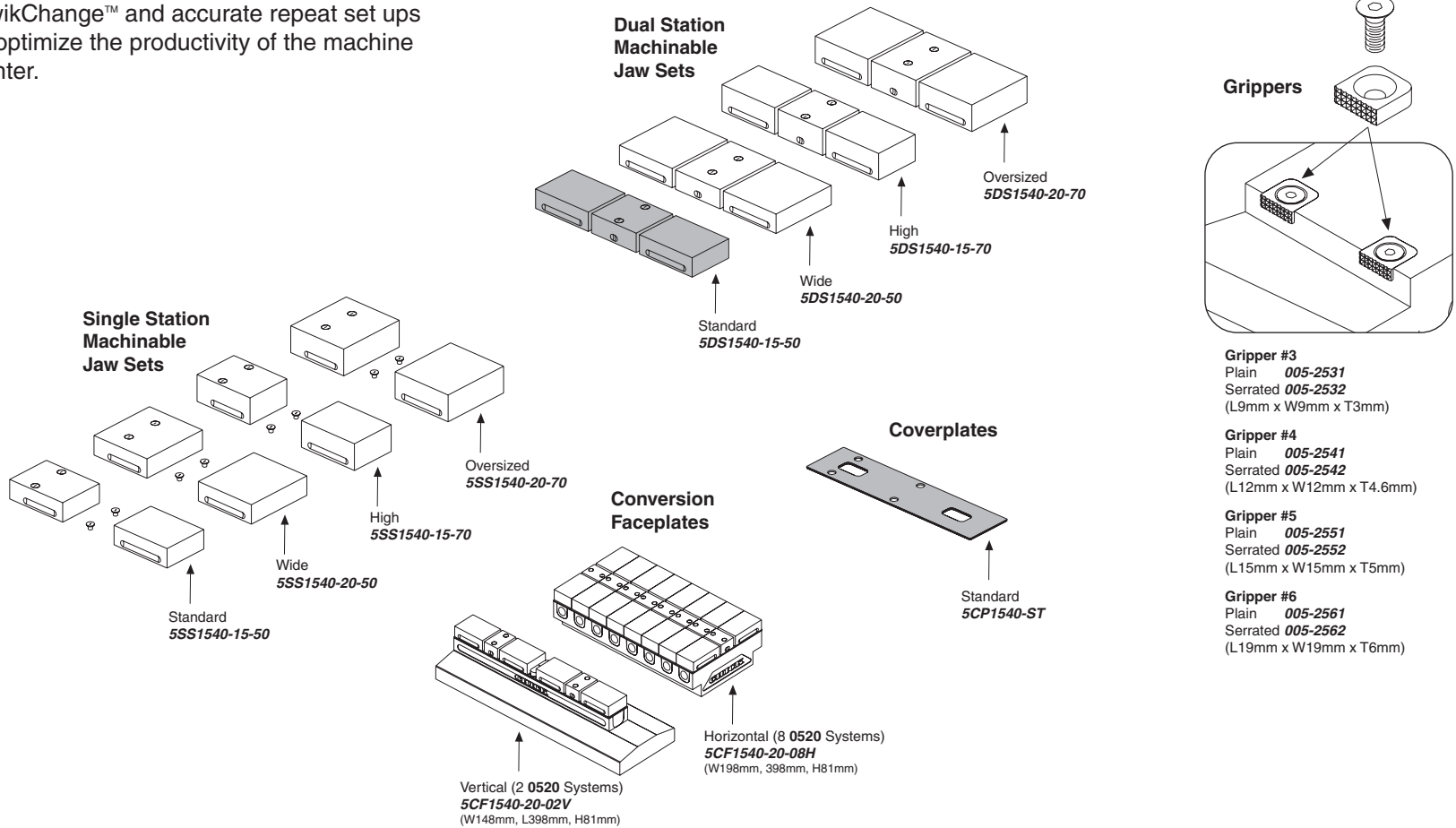

Notes

Grey item is included with a standard system

CHICK WORKHOLDING SOLUTIONS, INC.
 500 Keystone Drive • Warrendale, PA 15086 USA
 Phone: (724) 772-1644 • Fax: (724) 772-1633
 www.ChickWorkholding.com

Dedicated Fixturing

Machinable Faceplates provide QwikChange™ dedicated fixturing and are optimal for awkward or hard to hold parts. A mini pallet changer can be created by utilizing two Faceplates in tandem.

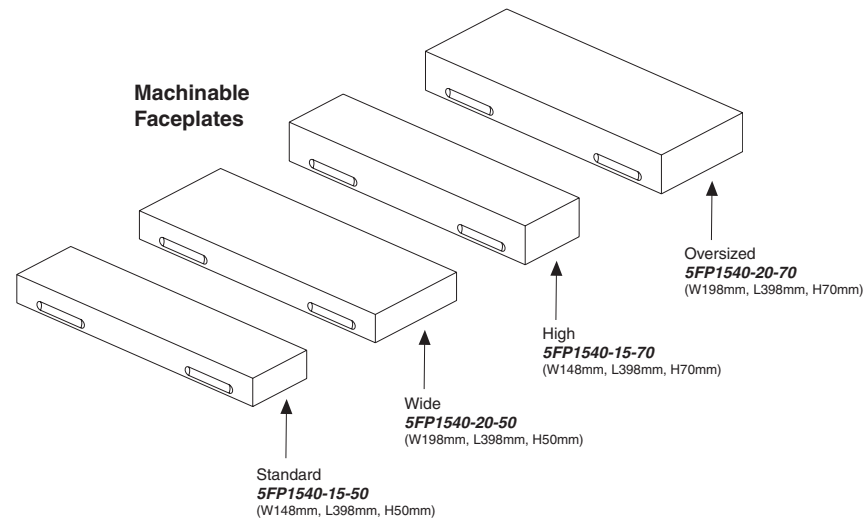

Notes

CHICK WORKHOLDING SOLUTIONS, INC.
 500 Keystone Drive • Warrendale, PA 15086 USA
 Phone: (724) 772-1644 • Fax: (724) 772-1633
www.ChickWorkholding.com

**QwikChange Machinable
Dual Station Jaws**

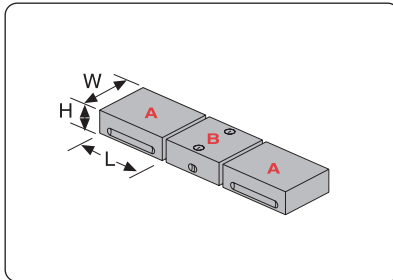

Individual Dual Station Jaws

Standard	
A Moveable Jaw	5MJ1540-15-50 (W148mm, H50mm, L135mm)
B Fixed Jaw	5FJ1540-15-50 (W148mm, H50mm, L100mm)
Wide	
A Moveable Jaw	5MJ1540-20-50 (W198mm, H50mm, L135mm)
B Fixed Jaw	5FJ1540-20-50 (W198mm, H50mm, L100mm)
High	
A Moveable Jaw	5MJ1540-15-70 (W148mm, H70mm, L135mm)
B Fixed Jaw	5FJ1540-15-70 (W148mm, H70mm, L100mm)
Oversized	
A Moveable Jaw	5MJ1540-20-70 (W198mm, H70mm, L135mm)
B Fixed Jaw	5FJ1540-20-70 (W198mm, H70mm, L100mm)

**QwikChange Machinable
Single Station Jaws**

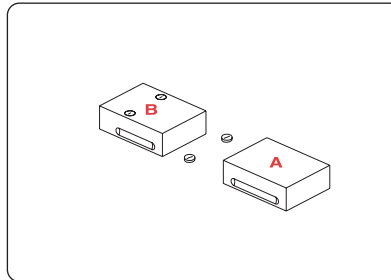

Individual Single Station Jaws

Standard	
A Moveable Jaw	5MJ1540-15-50 (W148mm, H50mm, L135mm)
B Fixed Jaw	5SJ1540-15-50 (W148mm, H50mm, L135mm)
Wide	
A Moveable Jaw	5MJ1540-20-50 (W198mm, H50mm, L135mm)
B Fixed Jaw	5SJ1540-20-50 (W198mm, H50mm, L135mm)
High	
A Moveable Jaw	5MJ1540-15-70 (W148mm, H70mm, L135mm)
B Fixed Jaw	5SJ1540-15-70 (W148mm, H70mm, L135mm)
Oversized	
A Moveable Jaw	5MJ1540-20-70 (W198mm, H70mm, L135mm)
B Fixed Jaw	5SJ1540-20-70 (W198mm, H70mm, L135mm)

Screws and Plugs

Dual Station

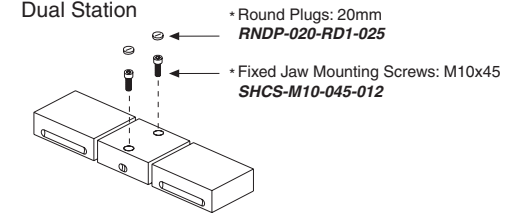

Single Station

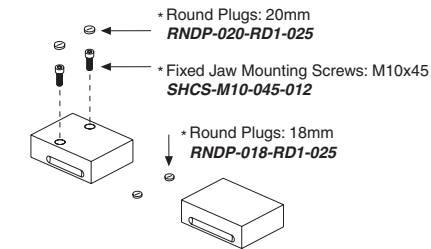

Faceplate Round & Diamond Pin Set

(Included w/ Faceplate purchase)

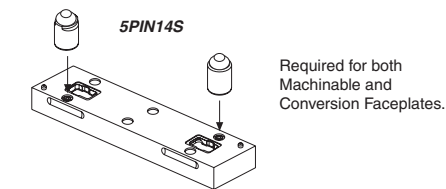

Notes

Grey or * item is included with a standard system

CHICK WORKHOLDING SOLUTIONS, INC.
500 Keystone Drive • Warrendale, PA 15086 USA
Phone: (724) 772-1644 • Fax: (724) 772-1633
www.ChickWorkholding.com

Dual Station

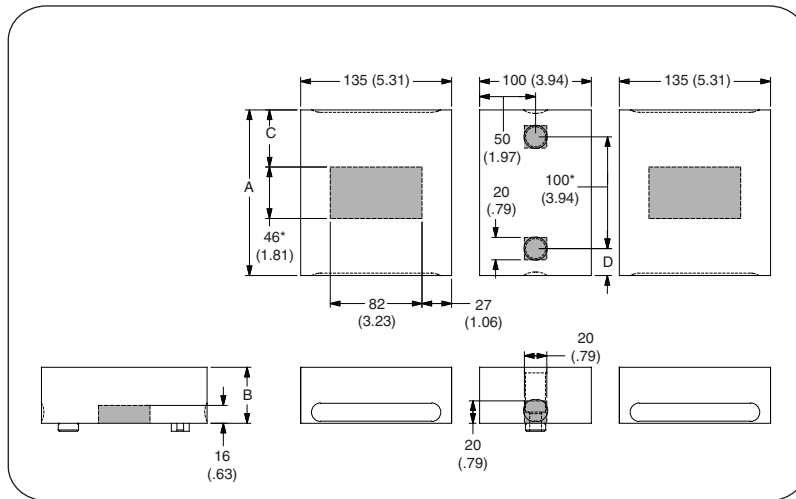

Single Station

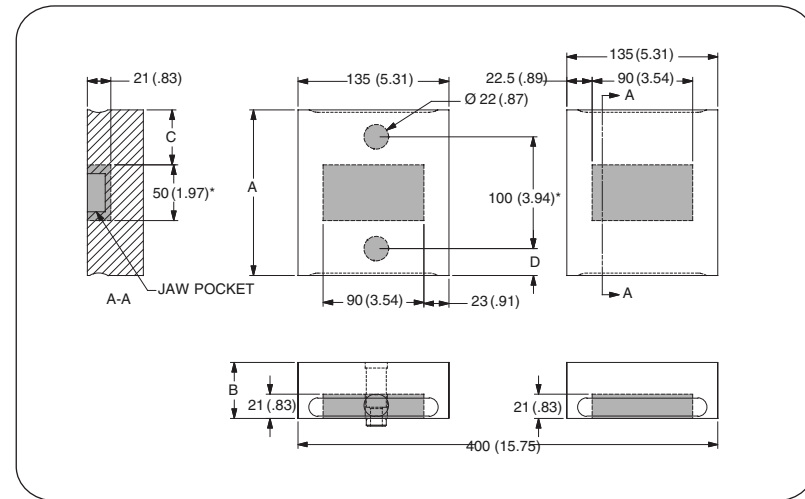

Item Number	Description	A	B	C	D
5DS1540-15-50	Standard	148 [5.83]	50 [1.97]	51 [2.01]	24 [.94]
5DS1540-15-70	High	148 [5.83]	70 [2.76]	51 [2.01]	24 [.94]
5DS1540-20-50	Wide	198 [7.80]	50 [1.97]	76 [2.99]	49 [1.93]
5DS1540-20-70	Oversized	198 [7.80]	70 [2.76]	76 [2.99]	49 [1.93]

Item Number	Description	A	B	C	D
5SS1540-15-50	Standard	148 [5.83]	50 [1.97]	49 [1.93]	24 [.94]
5SS1540-15-70	High	148 [5.83]	70 [2.76]	49 [1.93]	24 [.94]
5SS1540-20-50	Wide	198 [7.80]	50 [1.97]	74 [2.91]	49 [1.93]
5SS1540-20-70	Oversized	198 [7.80]	70 [2.76]	74 [2.91]	49 [1.93]

Notes

Grey area indicates no cut zone
 All dimensions are MM [IN]
 Dimensions centered on the "A" dimension.

CHICK WORKHOLDING SOLUTIONS, INC.
 500 Keystone Drive • Warrendale, PA 15086 USA
 Phone: (724) 772-1644 • Fax: (724) 772-1633
www.ChickWorkholding.com

Dual Station

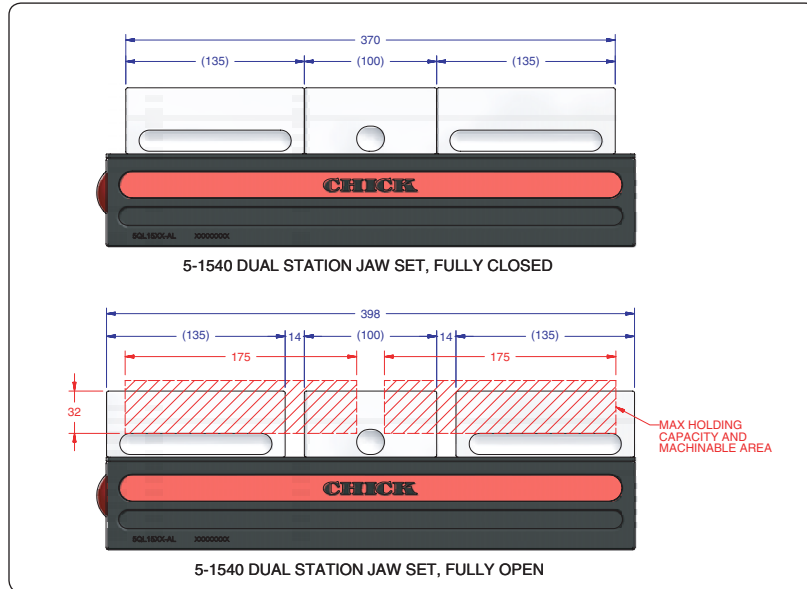

Item Number	Description	A	Jaw Width
5DS1540-15-50	Standard	32 [1.26]	148 [5.83]
5DS1540-15-70	High	52 [2.05]	148 [5.83]
5DS1540-20-50	Wide	32 [1.26]	198 [7.80]
5DS1540-20-70	Oversized	52 [2.05]	198 [7.80]

Single Station

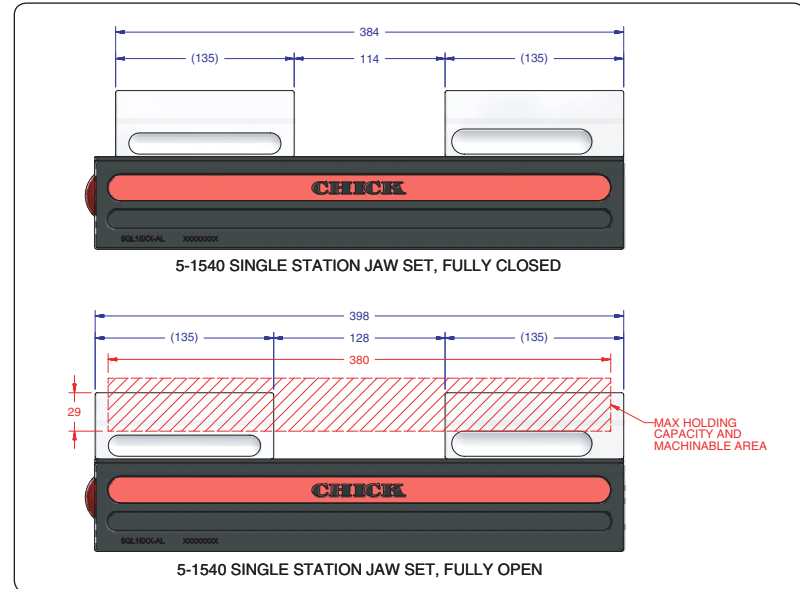

Item Number	Description	A	Jaw Width
5SS1540-15-50	Standard	29 [1.14]	148 [5.83]
5SS1540-15-70	High	49 [1.93]	148 [5.83]
5SS1540-20-50	Wide	29 [1.14]	198 [7.80]
5SS1540-20-70	Oversized	49 [1.93]	198 [7.80]

Notes

All dimensions are MM [IN]
 Additional closure is available with an Extended Travel Coverplate.
 Contact CHICK for details.

CHICK WORKHOLDING SOLUTIONS, INC.
 500 Keystone Drive • Warrendale, PA 15086 USA
 Phone: (724) 772-1644 • Fax: (724) 772-1633
www.ChickWorkholding.com

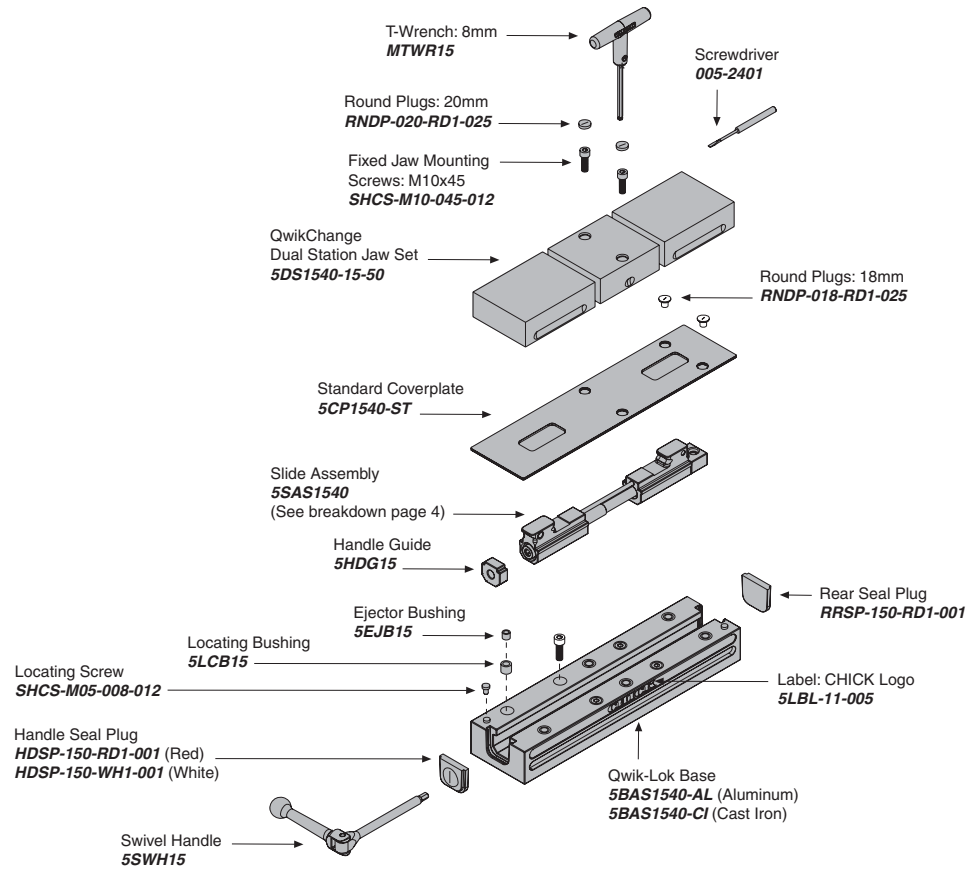

MOUNTING

Foundation

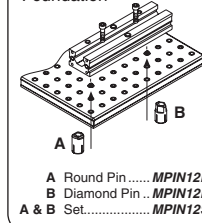

T-Slotted Table

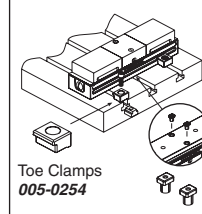

Bolt and T-Nut
supplied by customer

Bottom of Base

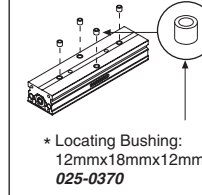

Locating Keys

Inch Size	
MKE500	(1/2")
MKE562	(9/16")
MKE625	(5/8")
MKE688	(11/16")
MKE750	(3/4")
MKE812	(13/16")
Metric Size	
MKE10	(10mm)
MKE12	(12mm)
MKE14X18	(14mm)
MKE16	(16mm)
MKE20	(20mm)

Notes
Grey items are included with a standard system
For QwikChange™ Jaw accessories, see pages 4-7

CHICK WORKHOLDING SOLUTIONS, INC.
500 Keystone Drive • Warrendale, PA 15086 USA
Phone: (724) 772-1644 • Fax: (724) 772-1633
www.ChickWorkholding.com

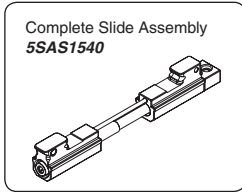

Notes

Grey items are included with a standard system

CHICK WORKHOLDING SOLUTIONS, INC.
 500 Keystone Drive • Warrendale, PA 15086 USA
 Phone: (724) 772-1644 • Fax: (724) 772-1633
www.ChickWorkholding.com

Pounds (lbs)

Force	=	Torque	X	Slope
lbs	=	in-lb	x	6.4
lbs	=	ft-lbs	x	76.3

Torque (ft-lb)	Force (lbs)
0	0
10	763
20	1525
30	2288
40	3051
50	3814
60	4576
70	5339
80	6102
90	6864
95	7246
100	7627
105	8008
110	8390
115	8771
118	9000

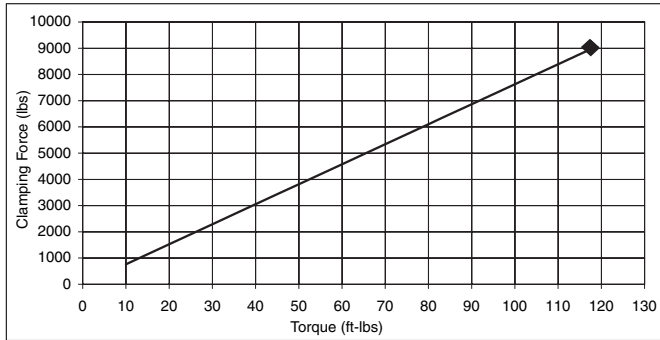

Note: **◆** Maximum Recommended Torque. Actual results may vary.

Kilonewtons (kN)

Force	=	Torque	X	Slope
N	=	N-m	x	250
kN	=	N-m	x	0.25

Torque (N-m)	Force (kN)
0	0.0
10	2.5
20	5.0
30	7.5
40	10.0
50	12.5
60	15.0
70	17.5
80	20.0
90	22.5
100	25.0
110	27.5
120	30.0
130	32.5
140	35.0
150	37.5
160	40.0

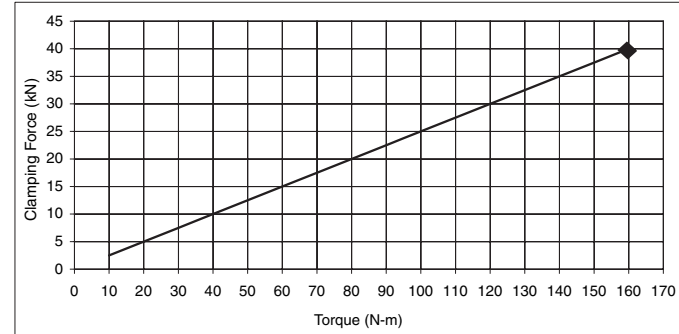

Note: **◆** Maximum Recommended Torque. Actual results may vary.

Notes

CHICK WORKHOLDING SOLUTIONS, INC.
 500 Keystone Drive • Warrendale, PA 15086 USA
 Phone: (724) 772-1644 • Fax: (724) 772-1633
www.ChickWorkholding.com