

## 5VP-HAAS-00225

This workholding package is designed for your HAAS VF-6 machining center.

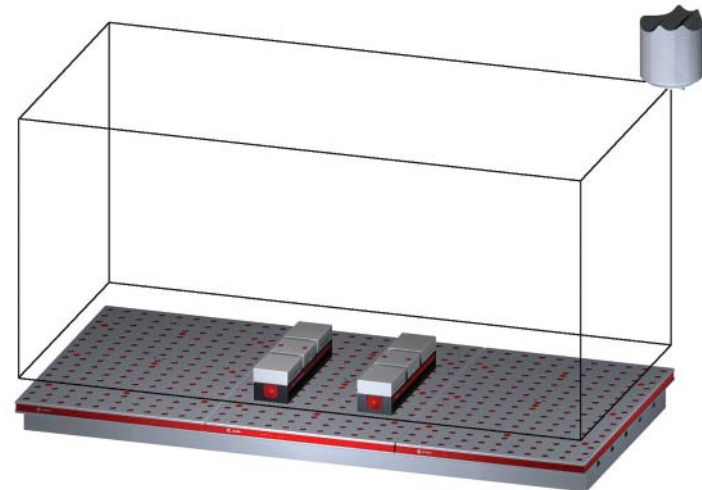

Workholding package



Workholding package  
in machine envelope

Notes

**CHICK WORKHOLDING SOLUTIONS, INC.**  
500 Keystone Drive • Warrendale, PA 15086 USA  
Phone: (724) 772-1644 • Fax: (724) 772-1633  
[www.ChickWorkholding.com](http://www.ChickWorkholding.com)

# 5VP-HAAS-00225

This workholding package is designed for your HAAS VF-6 machining center.

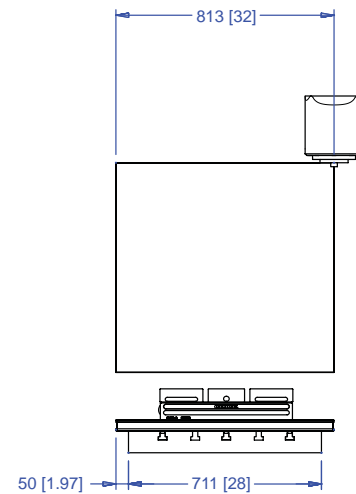
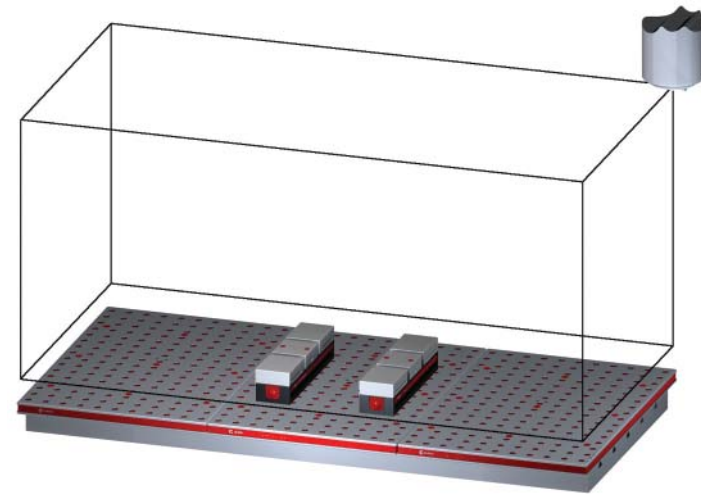
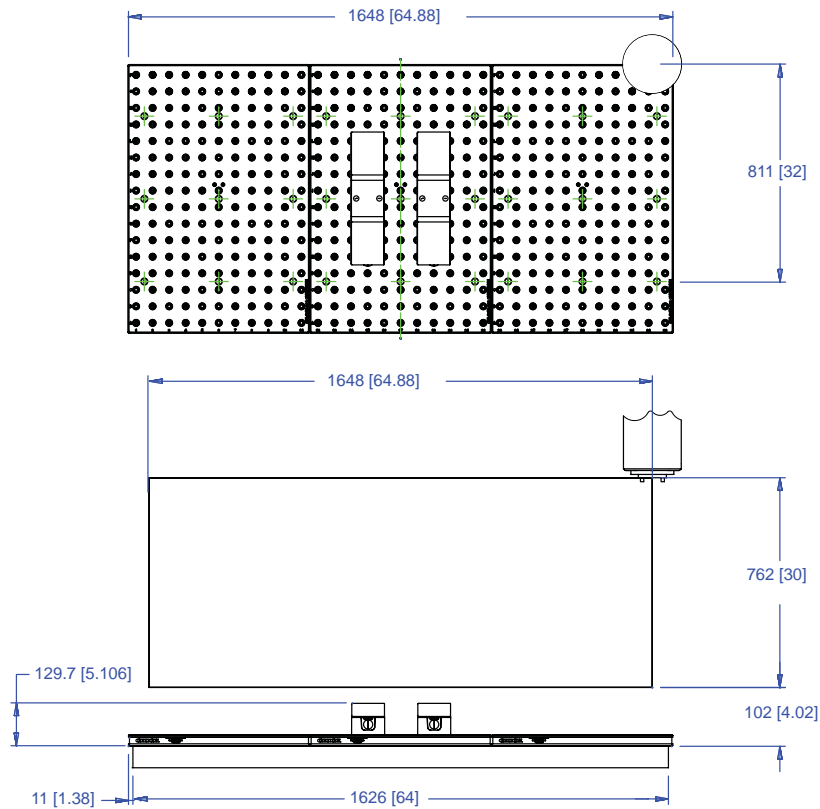

**Notes**

Machine travel may be limited by mechanical interference and/or machine safety zones. Please consult your machine's operating instructions for more information.

All dimensions are MM [IN]

**CHICK WORKHOLDING SOLUTIONS, INC.**  
 500 Keystone Drive • Warrendale, PA 15086 USA  
 Phone: (724) 772-1644 • Fax: (724) 772-1633  
[www.ChickWorkholding.com](http://www.ChickWorkholding.com)

# 5VP-HAAS-00225

This workholding package is designed for your HAAS VF-6 machining center.

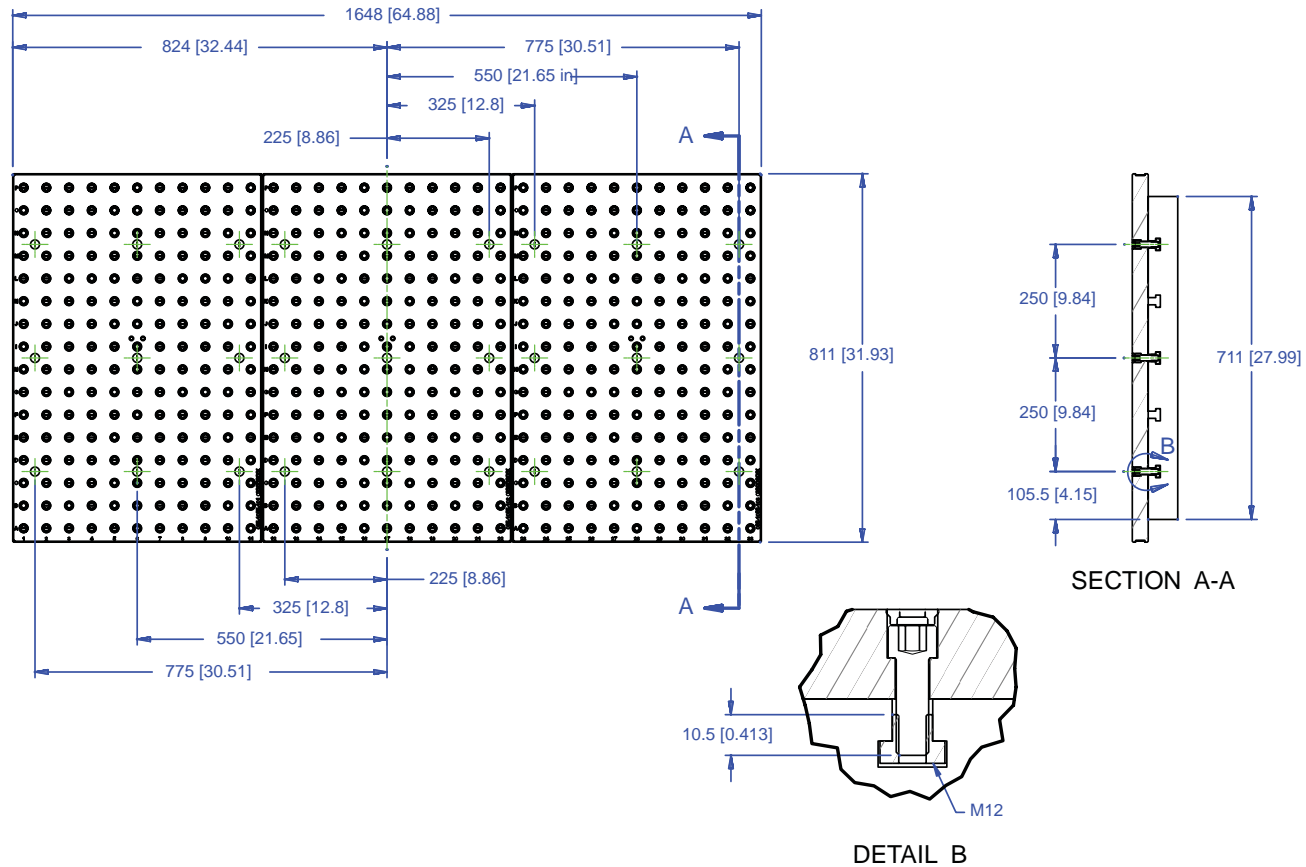

Notes  
All dimensions are MM [IN]

**CHICK WORKHOLDING SOLUTIONS, INC.**  
500 Keystone Drive • Warrendale, PA 15086 USA  
Phone: (724) 772-1644 • Fax: (724) 772-1633  
www.ChickWorkholding.com

# 5VP-HAAS-00225

This workholding package is designed for your HAAS VF-6 machining center.

FOUNDATION LENGTH, DEPTH, AND MOUNTING HOLE CONFIGURATION DESIGNED ACCORDING TO MACHINE TOOL SPECIFICATION



FOUNDATION MAT'L: CAST IRON  
FOUNDATION INCLUDES INSTALLATION HARDWARE

### DETAIL A

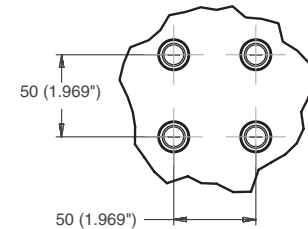

HOLE SPACING TOLERANCE  
 $\pm 0.02$  TO 500mm  
 $\pm 0.03$  TO 1200mm

### SECTION B-B

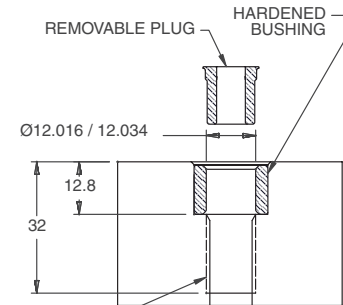

M12x1.75 TAP TO DEPTH SHOWN

Notes  
All dimensions are MM [IN]

**CHICK WORKHOLDING SOLUTIONS, INC.**  
500 Keystone Drive • Warrendale, PA 15086 USA  
Phone: (724) 772-1644 • Fax: (724) 772-1633  
[www.ChickWorkholding.com](http://www.ChickWorkholding.com)

## One-Off Workholding

Jaw carriers broaden your modern workholding flexibility by offering vise-like fixturing.

Simply QwikChange™ the jaws and your modern workholding is ready for one-off workholding needs.

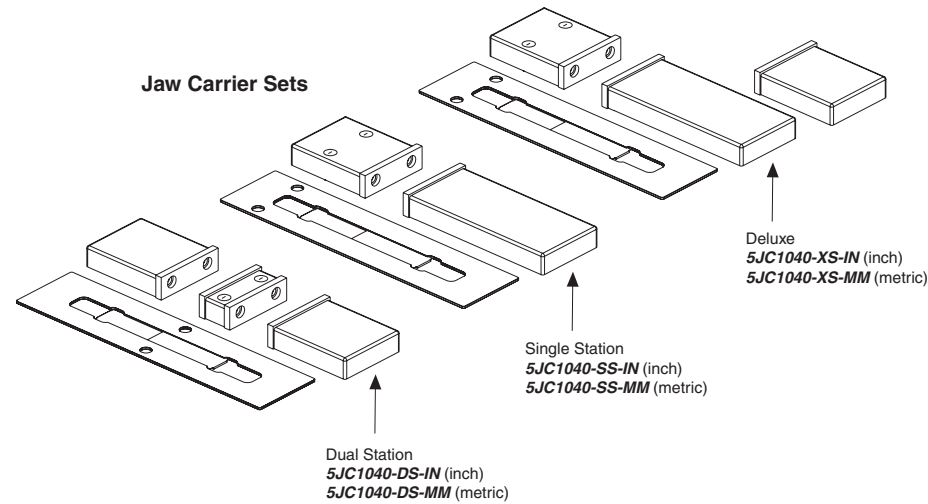

Notes

**CHICK WORKHOLDING SOLUTIONS, INC.**  
 500 Keystone Drive • Warrendale, PA 15086 USA  
 Phone: (724) 772-1644 • Fax: (724) 772-1633  
[www.ChickWorkholding.com](http://www.ChickWorkholding.com)

## Batch Production

Machinable accessories are the optimal solution for batch production. They offer QwikChange™ and accurate repeat set ups to optimize the productivity of the machine center.

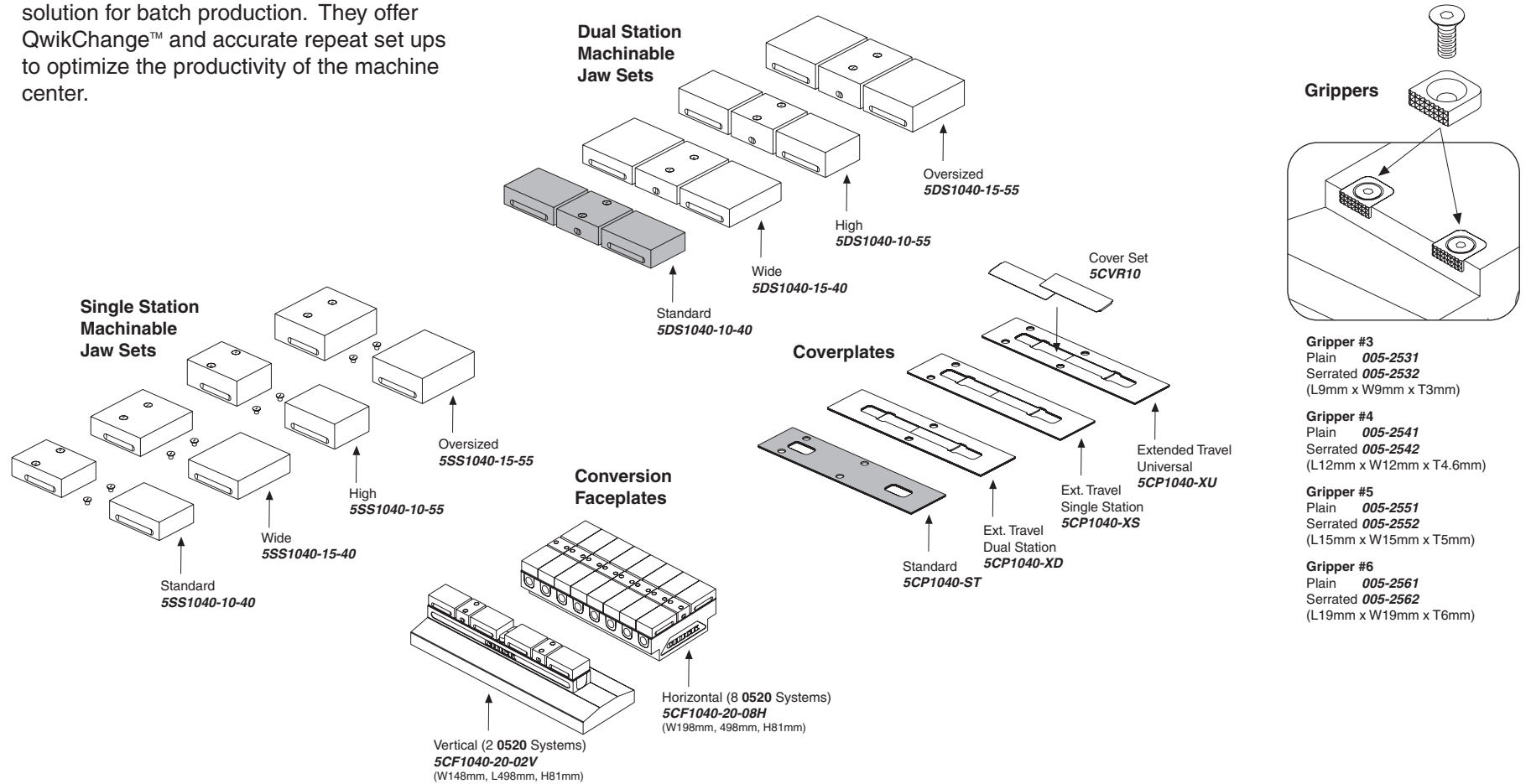

**Notes**

Grey item is included with a standard system

**CHICK WORKHOLDING SOLUTIONS, INC.**  
 500 Keystone Drive • Warrendale, PA 15086 USA  
 Phone: (724) 772-1644 • Fax: (724) 772-1633  
[www.ChickWorkholding.com](http://www.ChickWorkholding.com)

## Dedicated Fixturing

Machinable Faceplates provide QwikChange™ dedicated fixturing and are optimal for awkward or hard to hold parts. A mini pallet changer can be created by utilizing two Faceplates in tandem.



Notes

**CHICK WORKHOLDING SOLUTIONS, INC.**  
500 Keystone Drive • Warrendale, PA 15086 USA  
Phone: (724) 772-1644 • Fax: (724) 772-1633  
[www.ChickWorkholding.com](http://www.ChickWorkholding.com)

## QwikChange Machinable Dual Station Jaws

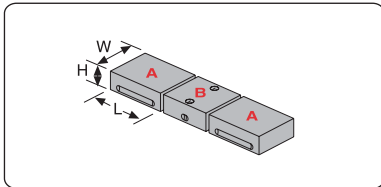

### Individual Dual Station Jaws

Standard

- A** Moveable Jaw ..... **5MJ1040-10-40**  
(W99mm, H130mm, L40mm)
- B** Fixed Jaw ..... **5FJ1040-10-40**  
(W99mm, H110mm, L40mm)

Wide

- A** Moveable Jaw ..... **5MJ1040-15-40**  
(W148mm, H130mm, L40mm)
- B** Fixed Jaw ..... **5FJ1040-15-40**  
(W148mm, H110mm, L40mm)

High

- A** Moveable Jaw ..... **5MJ1040-10-55**  
(W99mm, H130mm, L55mm)
- B** Fixed Jaw ..... **5FJ1040-10-55**  
(W99mm, H110mm, L55mm)

Oversized

- A** Moveable Jaw ..... **5MJ1040-15-55**  
(W148mm, H130mm, L55mm)
- B** Fixed Jaw ..... **5FJ1040-15-55**  
(W148mm, H110mm, L55mm)

## QwikChange Machinable Single Station Jaws

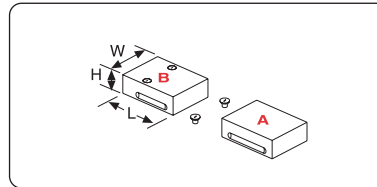

### Individual Single Station Jaws

Standard

- A** Moveable Jaw ..... **5MJ1040-10-40**  
(W99mm, H130mm, L40mm)
- B** Fixed Jaw ..... **5SJ1040-10-40**  
(W99mm, H130mm, L40mm)

Wide

- A** Moveable Jaw ..... **5MJ1040-15-40**  
(W148mm, H130mm, L40mm)
- B** Fixed Jaw ..... **5SJ1040-15-40**  
(W148mm, H130mm, L40mm)

High

- A** Moveable Jaw ..... **5MJ1040-10-55**  
(W99mm, H130mm, L55mm)
- B** Fixed Jaw ..... **5SJ1040-10-55**  
(W99mm, H130mm, L55mm)

Oversized

- A** Moveable Jaw ..... **5MJ1040-15-55**  
(W148mm, H130mm, L55mm)
- B** Fixed Jaw ..... **5SJ1040-15-55**  
(W148mm, H130mm, L55mm)

## QwikChange Jaw Carriers

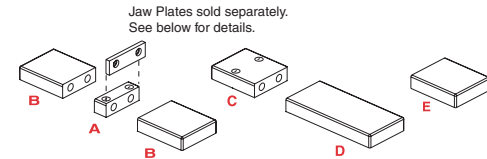

Jaw Carriers (Inch)

- A** 5JC1040-FC-IN
- B** 5JC1040-MC-IN
- C** 5JC1040-SC-IN
- D** 5JC1040-LM-IN
- E** 5JC1040-SM-IN

Jaw Carriers (Metric)

- A** 5JC1040-FC-MM
- B** 5JC1040-MC-MM
- C** 5JC1040-SC-MM
- D** 5JC1040-LM-MM
- E** 5JC1040-SM-MM

- A** Dual Station Fixed
- B** Dual Station Moveable

- C** Single Station Fixed
- D** Single Station Long Moveable

- E** Single Station Short Moveable

## Jaw Plates

### HARD JAW PLATES

- Standard (Set of 4)  
**JH4STD** (Inch)  
**MJH10** (Metric)

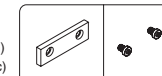

- Standard Mounting Screws: 3/8-16x1/2"  
**LHCS-375-050-008** (Inch)  
**LHCS-M08-016-008** (Metric)

- Thick (Set of 2)  
**JH4THK**

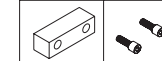

- Thick Mounting Screws: 3/8-16x1"  
**SHCS-375-100-012**

- Both Sizes  
**JH4STD** &  
**JH4THK**

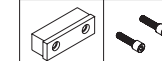

- Both Sizes Mounting Screws: 3/8-16x1.25"  
**SHCS-375-125-008**

### SOFT JAW PLATES

- Standard (Set of 4)  
**JS4AL**

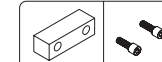

- Soft Mounting Screws: 3/8-16x1"  
**SHCS-375-100-012**

## Screws and Plugs

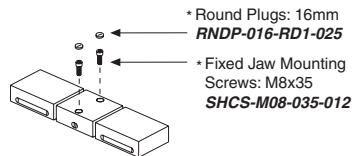

- \* Round Plugs: 16mm  
**RNDP-016-RD1-025**
- \* Fixed Jaw Mounting Screws: M8x35  
**SHCS-M08-035-012**

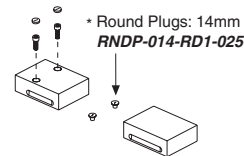

- \* Round Plugs: 14mm  
**RNDP-014-RD1-025**

## Notes

Grey or \* item is included with a standard system

**CHICK WORKHOLDING SOLUTIONS, INC.**  
500 Keystone Drive • Warrendale, PA 15086 USA  
Phone: (724) 772-1644 • Fax: (724) 772-1633  
www.ChickWorkholding.com



Dual Station



Single Station



Item Number	Description	A	B	C	D
<b>5DS1040-10-40</b>	Standard	99 [3.90]	40 [1.57]	34.5 [1.36]	14.5 [.57]
<b>5DS1040-10-55</b>	High	99 [3.90]	55 [2.17]	34.5 [1.36]	14.5 [.57]
<b>5DS1040-15-40</b>	Wide	148 [5.83]	40 [1.57]	59 [2.32]	39 [1.54]
<b>5DS1040-15-55</b>	Oversized	148 [5.83]	55 [2.17]	59 [2.32]	39 [1.54]

Item Number	Description	A	B	C	D
<b>5SS1040-10-40</b>	Standard	99 [3.90]	40 [1.57]	29.5 [1.16]	14.5 [.57]
<b>5SS1040-10-55</b>	High	99 [3.90]	55 [2.17]	29.5 [1.16]	14.5 [.57]
<b>5SS1040-15-40</b>	Wide	148 [5.83]	40 [1.57]	54 [2.13]	39 [1.54]
<b>5SS1040-15-55</b>	Oversized	148 [5.83]	55 [2.17]	54 [2.13]	39 [1.54]

Notes

Grey area indicates no cut zone  
 All dimensions are MM [IN]  
 Dimensions centered on the "A" dimension.

**CHICK WORKHOLDING SOLUTIONS, INC.**  
 500 Keystone Drive • Warrendale, PA 15086 USA  
 Phone: (724) 772-1644 • Fax: (724) 772-1633  
[www.ChickWorkholding.com](http://www.ChickWorkholding.com)

**Dual Station**



**Single Station**

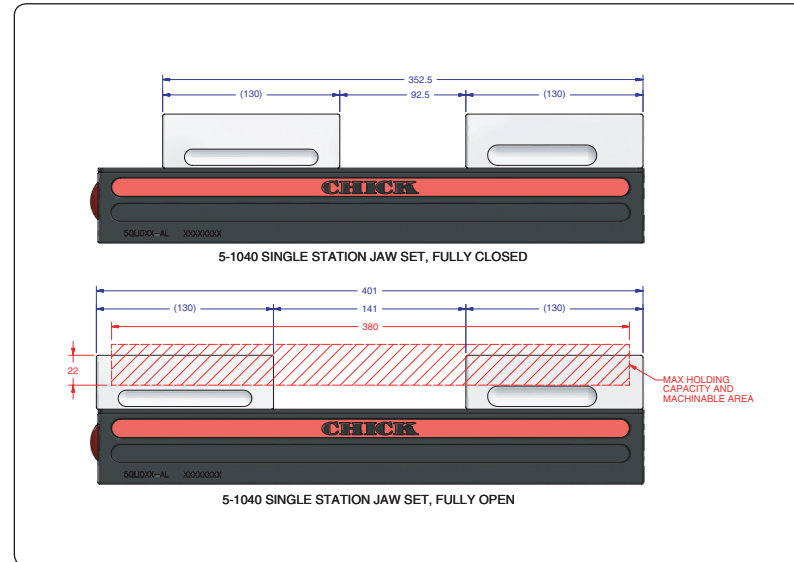

Item Number	Description	A	Jaw Width
<b>5DS1040-10-40</b>	Standard	26 [1.02]	99 [3.90]
<b>5DS1040-10-55</b>	High	41 [1.61]	99 [3.90]
<b>5DS1040-15-40</b>	Wide	26 [1.02]	148 [5.83]
<b>5DS1040-15-55</b>	Oversized	41 [1.61]	148 [5.83]

Item Number	Description	A	Jaw Width
<b>5SS1040-10-40</b>	Standard	26 [1.02]	99 [3.90]
<b>5SS1040-10-55</b>	High	41 [1.61]	99 [3.90]
<b>5SS1040-15-40</b>	Wide	26 [1.02]	148 [5.83]
<b>5SS1040-15-55</b>	Oversized	41 [1.61]	148 [5.83]

**Notes**

All dimensions are MM [IN]  
 Additional closure is available with an Extended Travel Coverplate.  
 Contact CHICK for details.

**CHICK WORKHOLDING SOLUTIONS, INC.**  
 500 Keystone Drive • Warrendale, PA 15086 USA  
 Phone: (724) 772-1644 • Fax: (724) 772-1633  
[www.ChickWorkholding.com](http://www.ChickWorkholding.com)



**MOUNTING**

**Foundation**



**T-Slotted Table**

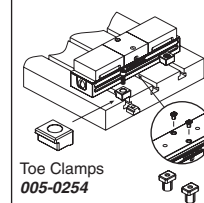

Bolt and T-Nut supplied by customer

**Bottom of Base**

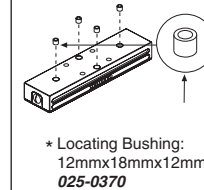

Locating Keys	
Inch Size	
MKE500	(1/2")
MKE562	(9/16")
MKE625	(5/8")
MKE688	(11/16")
MKE750	(3/4")
MKE812	(13/16")
Metric Size	
MKE10	(10mm)
MKE12	(12mm)
MKE14X18	(14mm)
MKE16	(16mm)
MKE20	(20mm)

**Notes**

Grey items are included with a standard system  
 For QwikChange™ Jaw accessories, see pages 5-8

**CHICK WORKHOLDING SOLUTIONS, INC.**  
 500 Keystone Drive • Warrendale, PA 15086 USA  
 Phone: (724) 772-1644 • Fax: (724) 772-1633  
 www.ChickWorkholding.com



**Notes**

Grey items are included with a standard system

**CHICK WORKHOLDING SOLUTIONS, INC.**  
 500 Keystone Drive • Warrendale, PA 15086 USA  
 Phone: (724) 772-1644 • Fax: (724) 772-1633  
[www.ChickWorkholding.com](http://www.ChickWorkholding.com)

**Pounds (lbs)**

Force	=	Torque	X	Slope
lbs	=	in-lb	x	8.0
lbs	=	ft-lbs	x	96

Torque (ft-lb)	Force (lbs)
0	0
10	962
20	1923
30	2885
40	3846
50	4808
52	5000



Note: ◆ Maximum Recommended Torque. Actual results may vary.

**Kilonewtons (kN)**

Force	=	Torque	X	Slope
N	=	N-m	x	315
kN	=	N-m	x	0.315

Torque (N-m)	Force (kN)
0	0.0
10	3.1
20	6.3
30	9.4
40	12.6
50	15.7
60	18.9
65	20.5
70	22.0

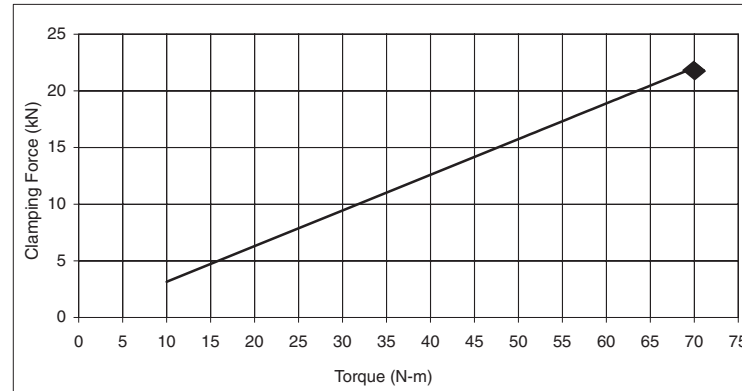

Note: ◆ Maximum Recommended Torque. Actual results may vary.

Notes

**CHICK WORKHOLDING SOLUTIONS, INC.**  
 500 Keystone Drive • Warrendale, PA 15086 USA  
 Phone: (724) 772-1644 • Fax: (724) 772-1633  
[www.ChickWorkholding.com](http://www.ChickWorkholding.com)