

5VP-HAAS-00245

This workholding package is designed for your HAAS VF-2 machining center.

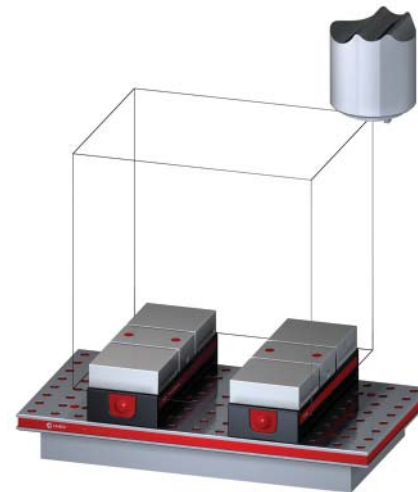

Workholding package



Workholding package
in machine envelope

Notes

CHICK WORKHOLDING SOLUTIONS, INC.
500 Keystone Drive • Warrendale, PA 15086 USA
Phone: (724) 772-1644 • Fax: (724) 772-1633
www.ChickWorkholding.com

5VP-HAAS-00245

This workholding package is designed for your HAAS VF-2 machining center.

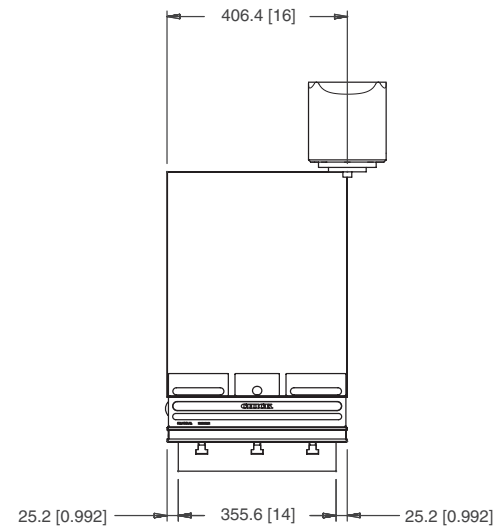
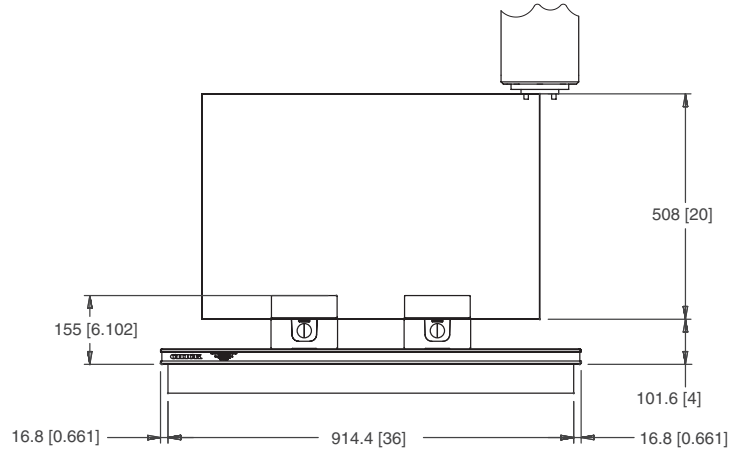
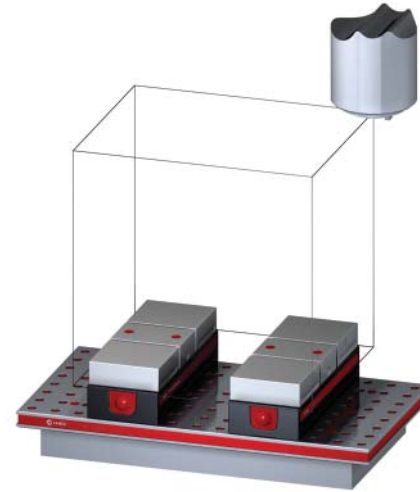
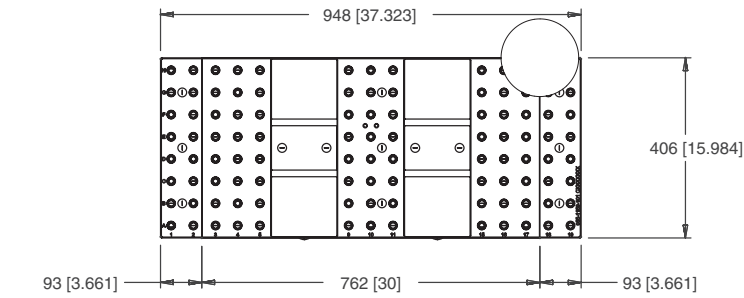

Notes

Machine travel may be limited by mechanical interference and/or machine safety zones. Please consult your machine's operating instructions for more information.

All dimensions are MM [IN]

CHICK WORKHOLDING SOLUTIONS, INC.
 500 Keystone Drive • Warrendale, PA 15086 USA
 Phone: (724) 772-1644 • Fax: (724) 772-1633
www.ChickWorkholding.com

5VP-HAAS-00245

This workholding package is designed for your HAAS VF-2 machining center.

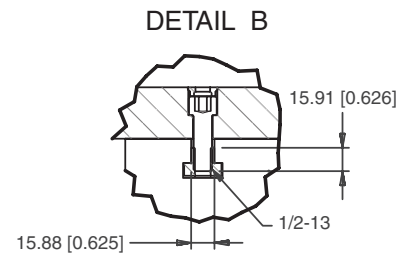
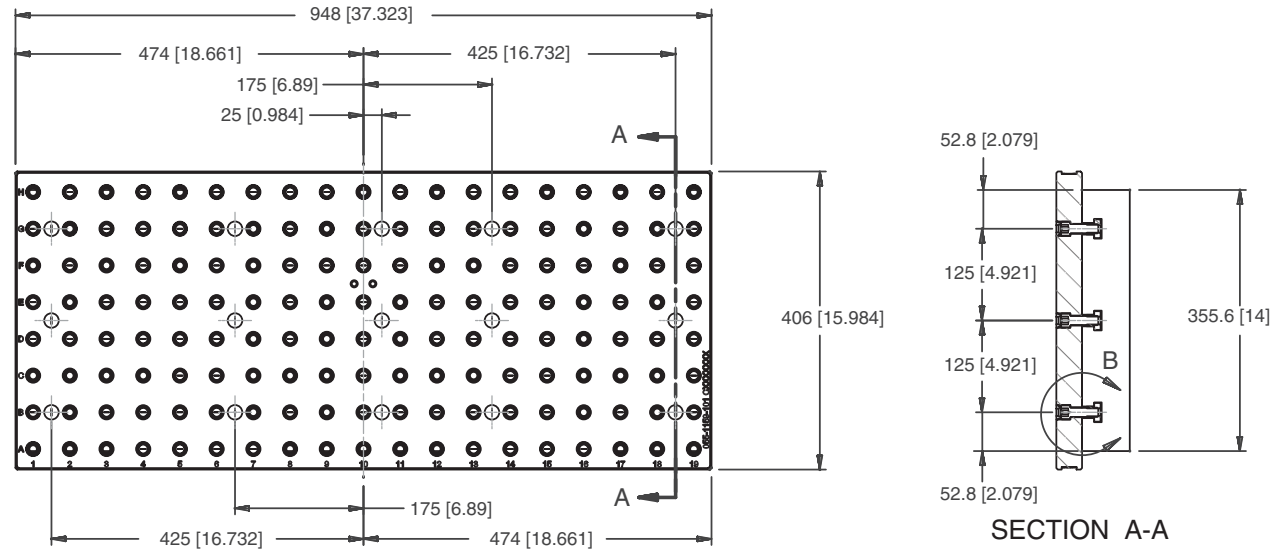

Notes
All dimensions are MM [IN]

CHICK WORKHOLDING SOLUTIONS, INC.
500 Keystone Drive • Warrendale, PA 15086 USA
Phone: (724) 772-1644 • Fax: (724) 772-1633
www.ChickWorkholding.com

5VP-HAAS-00245

This workholding package is designed for your HAAS VF-2 machining center.

FOUNDATION LENGTH, DEPTH, AND MOUNTING HOLE CONFIGURATION DESIGNED ACCORDING TO MACHINE TOOL SPECIFICATION



FOUNDATION MAT'L: CAST IRON
FOUNDATION INCLUDES INSTALLATION HARDWARE

DETAIL A



HOLE SPACING TOLERANCE
±0.02 TO 500mm
±0.03 TO 1200mm

SECTION B-B

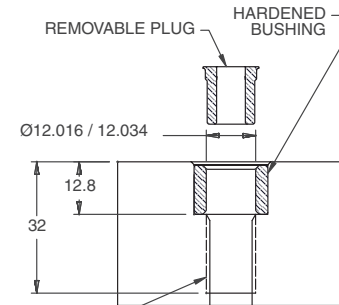

Notes
All dimensions are MM [IN]

CHICK WORKHOLDING SOLUTIONS, INC.
500 Keystone Drive • Warrendale, PA 15086 USA
Phone: (724) 772-1644 • Fax: (724) 772-1633
www.ChickWorkholding.com

Batch Production

Machinable accessories are the optimal solution for batch production. They offer QwikChange™ and accurate repeat set ups to optimize the productivity of the machine center.

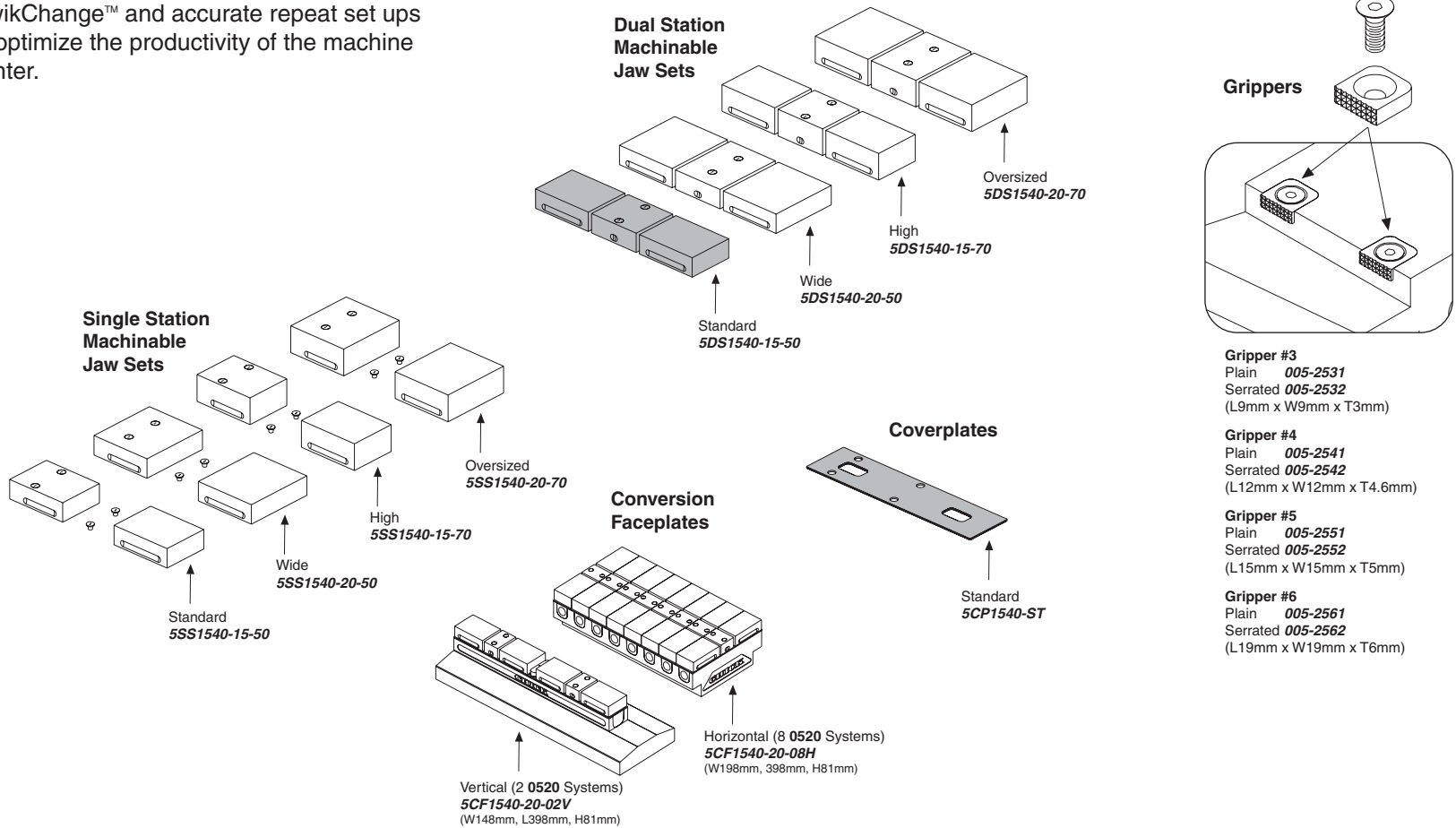

Notes

Grey item is included with a standard system

CHICK WORKHOLDING SOLUTIONS, INC.
 500 Keystone Drive • Warrendale, PA 15086 USA
 Phone: (724) 772-1644 • Fax: (724) 772-1633
www.ChickWorkholding.com

Dedicated Fixturing

Machinable Faceplates provide QwikChange™ dedicated fixturing and are optimal for awkward or hard to hold parts. A mini pallet changer can be created by utilizing two Faceplates in tandem.

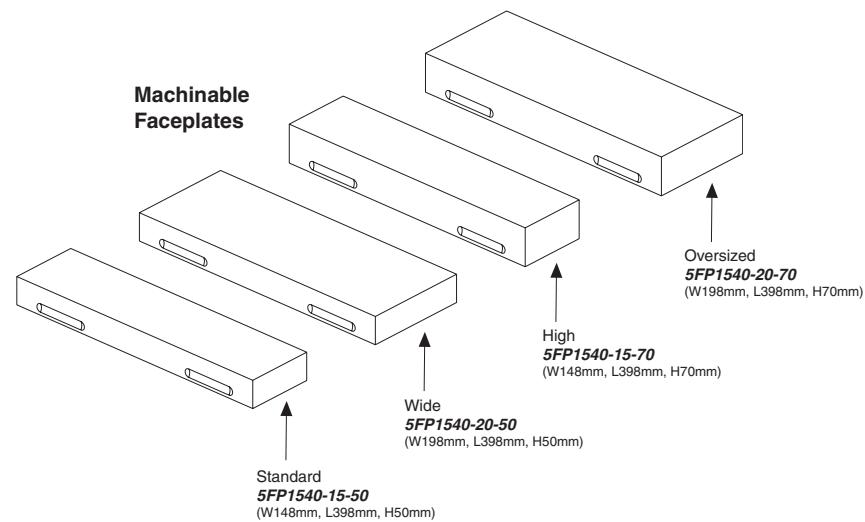

Notes

CHICK WORKHOLDING SOLUTIONS, INC.
500 Keystone Drive • Warrendale, PA 15086 USA
Phone: (724) 772-1644 • Fax: (724) 772-1633
www.ChickWorkholding.com

QwikChange Machinable Dual Station Jaws

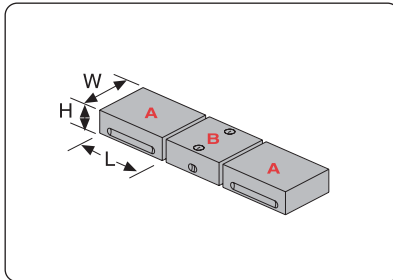

Individual Dual Station Jaws

| | |
|-----------------------------|---|
| Standard | |
| A Moveable Jaw | 5MJ1540-15-50 (W148mm, H50mm, L135mm) |
| B Fixed Jaw | 5FJ1540-15-50 (W148mm, H50mm, L100mm) |
| Wide | |
| A Moveable Jaw | 5MJ1540-20-50 (W198mm, H50mm, L135mm) |
| B Fixed Jaw | 5FJ1540-20-50 (W198mm, H50mm, L100mm) |
| High | |
| A Moveable Jaw | 5MJ1540-15-70 (W148mm, H70mm, L135mm) |
| B Fixed Jaw | 5FJ1540-15-70 (W148mm, H70mm, L100mm) |
| Oversized | |
| A Moveable Jaw | 5MJ1540-20-70 (W198mm, H70mm, L135mm) |
| B Fixed Jaw | 5FJ1540-20-70 (W198mm, H70mm, L100mm) |

QwikChange Machinable Single Station Jaws

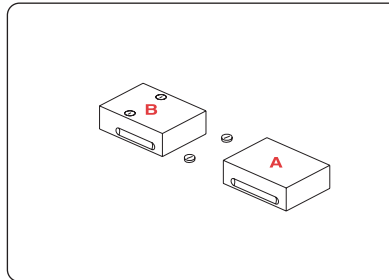

Individual Single Station Jaws

| | |
|-----------------------------|---|
| Standard | |
| A Moveable Jaw | 5MJ1540-15-50 (W148mm, H50mm, L135mm) |
| B Fixed Jaw | 5SJ1540-15-50 (W148mm, H50mm, L135mm) |
| Wide | |
| A Moveable Jaw | 5MJ1540-20-50 (W198mm, H50mm, L135mm) |
| B Fixed Jaw | 5SJ1540-20-50 (W198mm, H50mm, L135mm) |
| High | |
| A Moveable Jaw | 5MJ1540-15-70 (W148mm, H70mm, L135mm) |
| B Fixed Jaw | 5SJ1540-15-70 (W148mm, H70mm, L135mm) |
| Oversized | |
| A Moveable Jaw | 5MJ1540-20-70 (W198mm, H70mm, L135mm) |
| B Fixed Jaw | 5SJ1540-20-70 (W198mm, H70mm, L135mm) |

Screws and Plugs

Dual Station

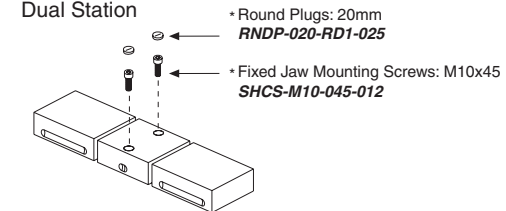

Single Station

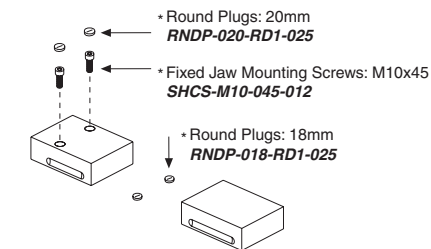

Faceplate Round & Diamond Pin Set

(Included w/ Faceplate purchase)

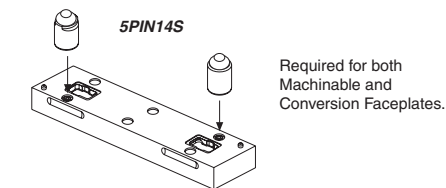

Notes

Grey or * item is included with a standard system

CHICK WORKHOLDING SOLUTIONS, INC.
500 Keystone Drive • Warrendale, PA 15086 USA
Phone: (724) 772-1644 • Fax: (724) 772-1633
www.ChickWorkholding.com

Dual Station

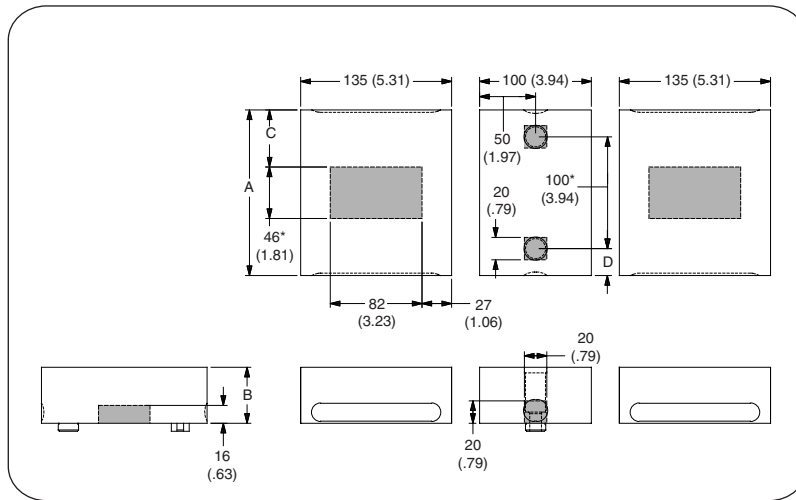

Single Station

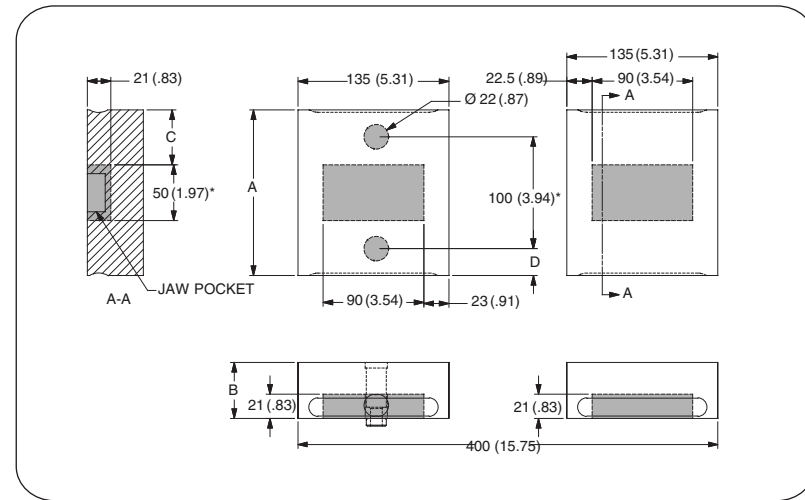

| Item Number | Description | A | B | C | D |
|---------------|-------------|------------|-----------|-----------|-----------|
| 5DS1540-15-50 | Standard | 148 [5.83] | 50 [1.97] | 51 [2.01] | 24 [.94] |
| 5DS1540-15-70 | High | 148 [5.83] | 70 [2.76] | 51 [2.01] | 24 [.94] |
| 5DS1540-20-50 | Wide | 198 [7.80] | 50 [1.97] | 76 [2.99] | 49 [1.93] |
| 5DS1540-20-70 | Oversized | 198 [7.80] | 70 [2.76] | 76 [2.99] | 49 [1.93] |

| Item Number | Description | A | B | C | D |
|---------------|-------------|------------|-----------|-----------|-----------|
| 5SS1540-15-50 | Standard | 148 [5.83] | 50 [1.97] | 49 [1.93] | 24 [.94] |
| 5SS1540-15-70 | High | 148 [5.83] | 70 [2.76] | 49 [1.93] | 24 [.94] |
| 5SS1540-20-50 | Wide | 198 [7.80] | 50 [1.97] | 74 [2.91] | 49 [1.93] |
| 5SS1540-20-70 | Oversized | 198 [7.80] | 70 [2.76] | 74 [2.91] | 49 [1.93] |

Notes

Grey area indicates no cut zone
 All dimensions are MM [IN]
 Dimensions centered on the "A" dimension.

CHICK WORKHOLDING SOLUTIONS, INC.
 500 Keystone Drive • Warrendale, PA 15086 USA
 Phone: (724) 772-1644 • Fax: (724) 772-1633
www.ChickWorkholding.com

Dual Station

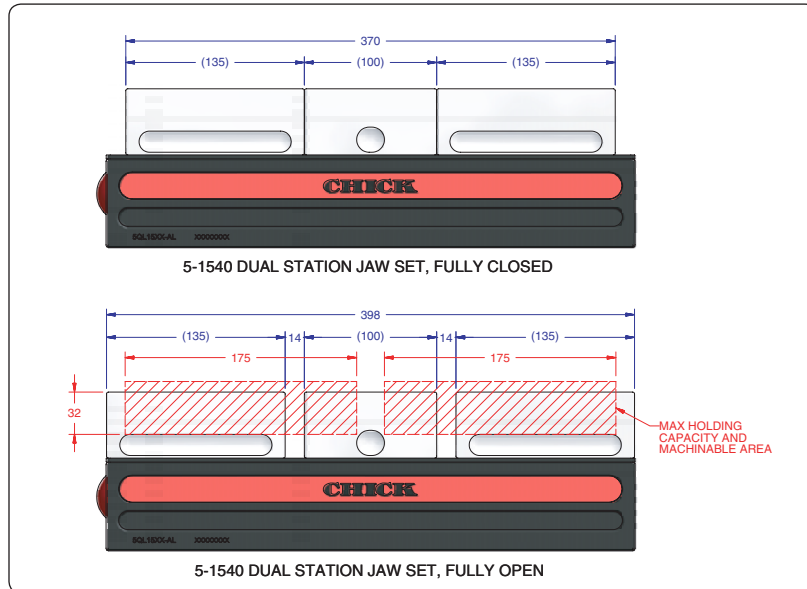

| Item Number | Description | A | Jaw Width |
|---------------|-------------|-----------|------------|
| 5DS1540-15-50 | Standard | 32 [1.26] | 148 [5.83] |
| 5DS1540-15-70 | High | 52 [2.05] | 148 [5.83] |
| 5DS1540-20-50 | Wide | 32 [1.26] | 198 [7.80] |
| 5DS1540-20-70 | Oversized | 52 [2.05] | 198 [7.80] |

Single Station

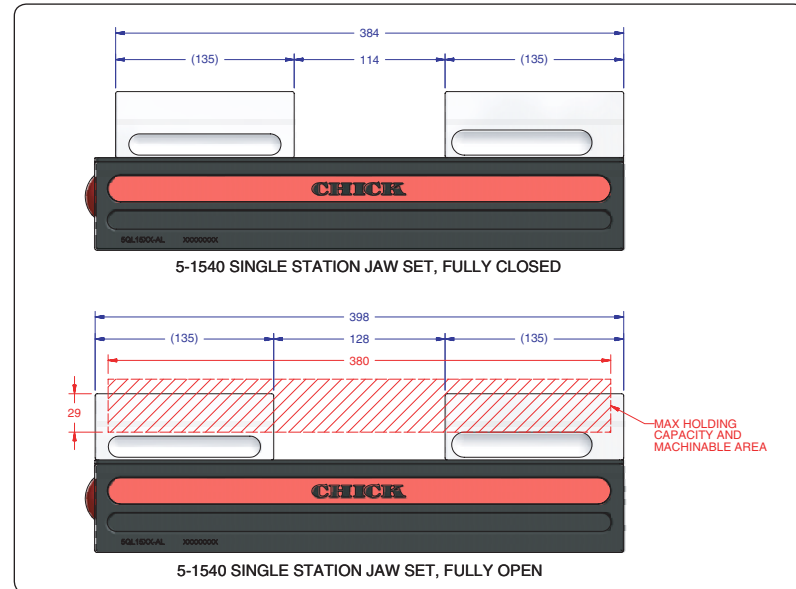

| Item Number | Description | A | Jaw Width |
|---------------|-------------|-----------|------------|
| 5SS1540-15-50 | Standard | 29 [1.14] | 148 [5.83] |
| 5SS1540-15-70 | High | 49 [1.93] | 148 [5.83] |
| 5SS1540-20-50 | Wide | 29 [1.14] | 198 [7.80] |
| 5SS1540-20-70 | Oversized | 49 [1.93] | 198 [7.80] |

Notes

All dimensions are MM [IN]
 Additional closure is available with an Extended Travel Coverplate.
 Contact CHICK for details.

CHICK WORKHOLDING SOLUTIONS, INC.
 500 Keystone Drive • Warrendale, PA 15086 USA
 Phone: (724) 772-1644 • Fax: (724) 772-1633
www.ChickWorkholding.com

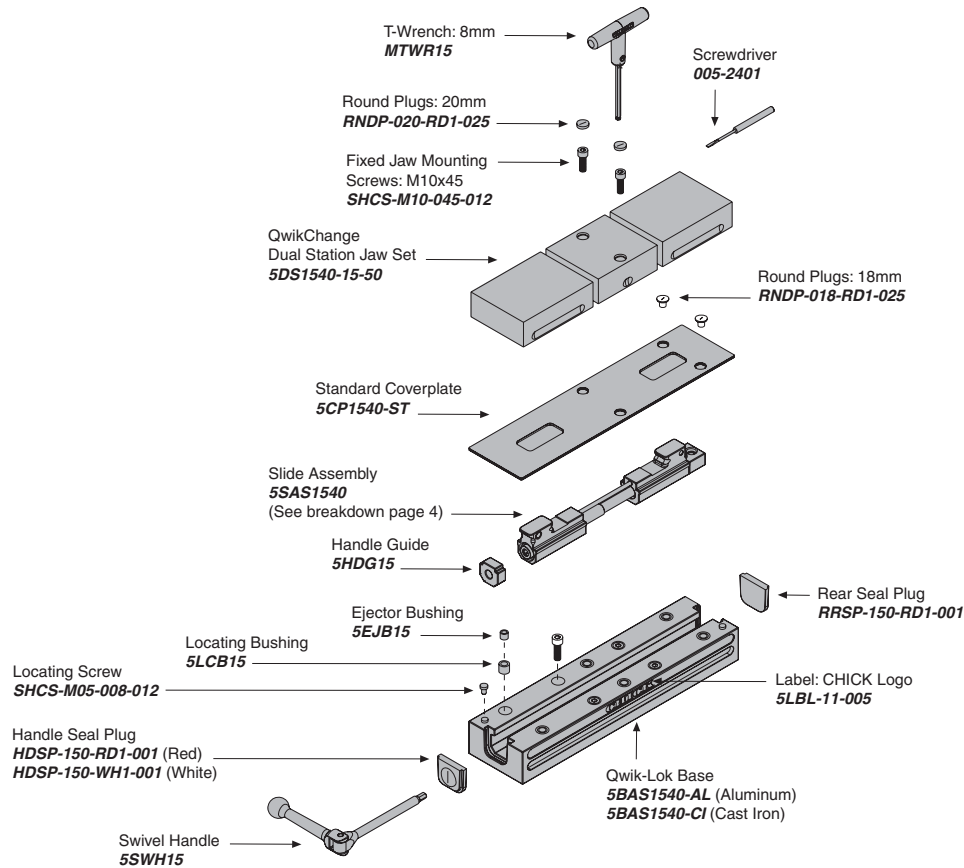

MOUNTING

Foundation

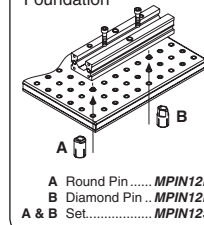

T-Slotted Table

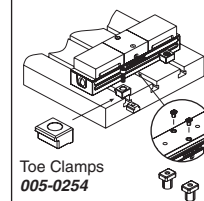

Bolt and T-Nut supplied by customer

Bottom of Base

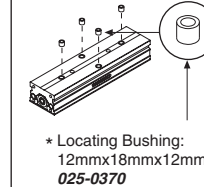

Locating Keys

| Inch Size |
|-----------------|
| MKE500 (1/2") |
| MKE562 (9/16") |
| MKE625 (5/8") |
| MKE688 (11/16") |
| MKE750 (3/4") |
| MKE812 (13/16") |
| Metric Size |
| MKE10 (10mm) |
| MKE12 (12mm) |
| MKE14X18 (14mm) |
| MKE16 (16mm) |
| MKE20 (20mm) |

Notes

Grey items are included with a standard system
 For QwikChange™ Jaw accessories, see pages 4-7

CHICK WORKHOLDING SOLUTIONS, INC.
 500 Keystone Drive • Warrendale, PA 15086 USA
 Phone: (724) 772-1644 • Fax: (724) 772-1633
 www.ChickWorkholding.com

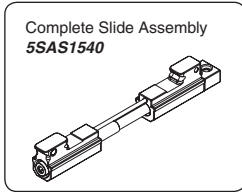

Notes

Grey items are included with a standard system

CHICK WORKHOLDING SOLUTIONS, INC.
 500 Keystone Drive • Warrendale, PA 15086 USA
 Phone: (724) 772-1644 • Fax: (724) 772-1633
www.ChickWorkholding.com

Pounds (lbs)

| | | | | |
|-------|---|--------|---|-------|
| Force | = | Torque | X | Slope |
| lbs | = | in-lb | x | 6.4 |
| lbs | = | ft-lbs | x | 76.3 |

| Torque (ft-lb) | Force (lbs) |
|----------------|-------------|
| 0 | 0 |
| 10 | 763 |
| 20 | 1525 |
| 30 | 2288 |
| 40 | 3051 |
| 50 | 3814 |
| 60 | 4576 |
| 70 | 5339 |
| 80 | 6102 |
| 90 | 6864 |
| 95 | 7246 |
| 100 | 7627 |
| 105 | 8008 |
| 110 | 8390 |
| 115 | 8771 |
| 118 | 9000 |

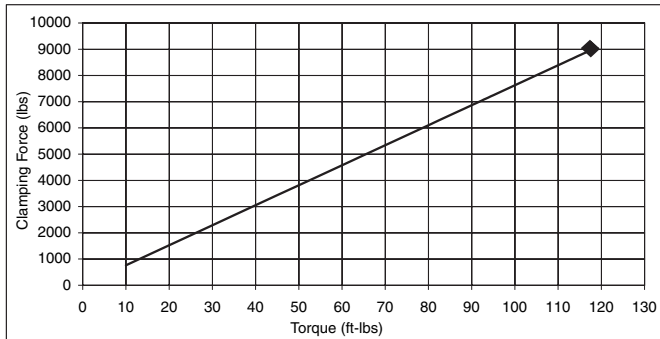

Note: **◆** Maximum Recommended Torque. Actual results may vary.

Kilonewtons (kN)

| | | | | |
|-------|---|--------|---|-------|
| Force | = | Torque | X | Slope |
| N | = | N-m | x | 250 |
| kN | = | N-m | x | 0.25 |

| Torque (N-m) | Force (kN) |
|--------------|------------|
| 0 | 0.0 |
| 10 | 2.5 |
| 20 | 5.0 |
| 30 | 7.5 |
| 40 | 10.0 |
| 50 | 12.5 |
| 60 | 15.0 |
| 70 | 17.5 |
| 80 | 20.0 |
| 90 | 22.5 |
| 100 | 25.0 |
| 110 | 27.5 |
| 120 | 30.0 |
| 130 | 32.5 |
| 140 | 35.0 |
| 150 | 37.5 |
| 160 | 40.0 |

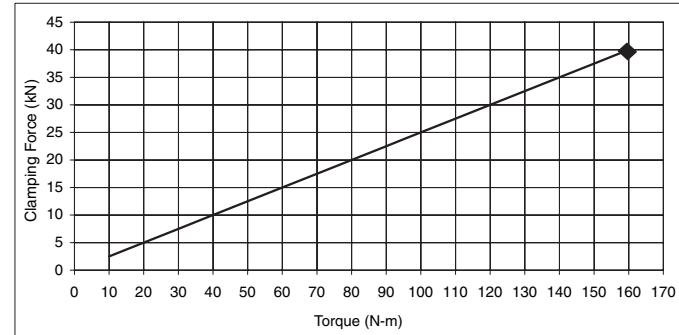

Note: **◆** Maximum Recommended Torque. Actual results may vary.

Notes

CHICK WORKHOLDING SOLUTIONS, INC.
 500 Keystone Drive • Warrendale, PA 15086 USA
 Phone: (724) 772-1644 • Fax: (724) 772-1633
www.ChickWorkholding.com