

## 5VP-KITA-00055

This workholding package is designed for your KITAMURA 3XiF-Sparkchanger machining center.



Notes

**CHICK WORKHOLDING SOLUTIONS, INC**  
500 Keystone Drive • Warrendale, PA 15086 USA  
Phone: (724) 772-1644 • Fax: (724) 772-1633  
Toll Free: (800) 33-CHICK • (800) 332-4425  
[www.ChickWorkholding.com](http://www.ChickWorkholding.com)

# 5VP-KITA-00055

This workholding package is designed for your KITAMURA 3XiF-Sparkchanger machining center.

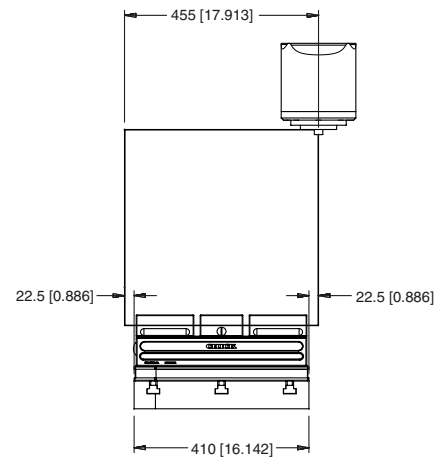
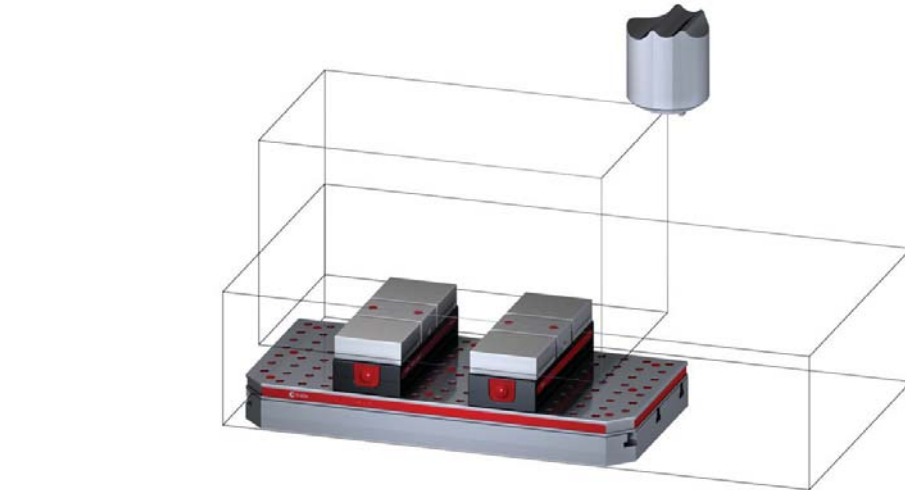
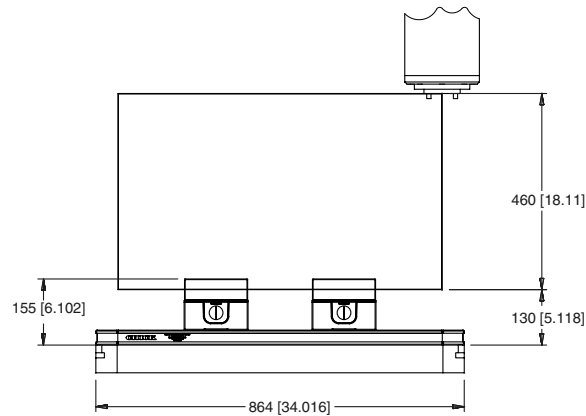
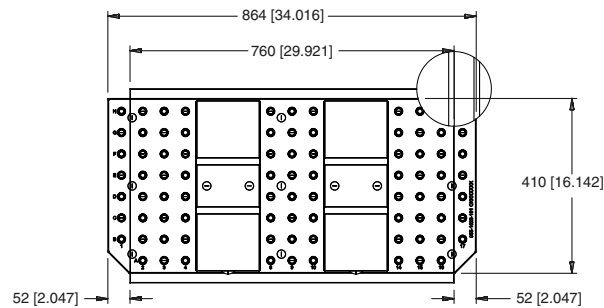

**Notes**

Machine travel may be limited by mechanical interference and/or machine safety zones. Please consult your machine's operating instructions for more information.

All dimensions are MM [IN]

**CHICK WORKHOLDING SOLUTIONS, INC**  
 500 Keystone Drive • Warrendale, PA 15086 USA  
 Phone: (724) 772-1644 • Fax: (724) 772-1633  
 Toll Free: (800) 33-CHICK • (800) 332-4425  
[www.ChickWorkholding.com](http://www.ChickWorkholding.com)

# 5VP-KITA-00055

This workholding package is designed for your KITAMURA 3XiF-Sparkchanger machining center.

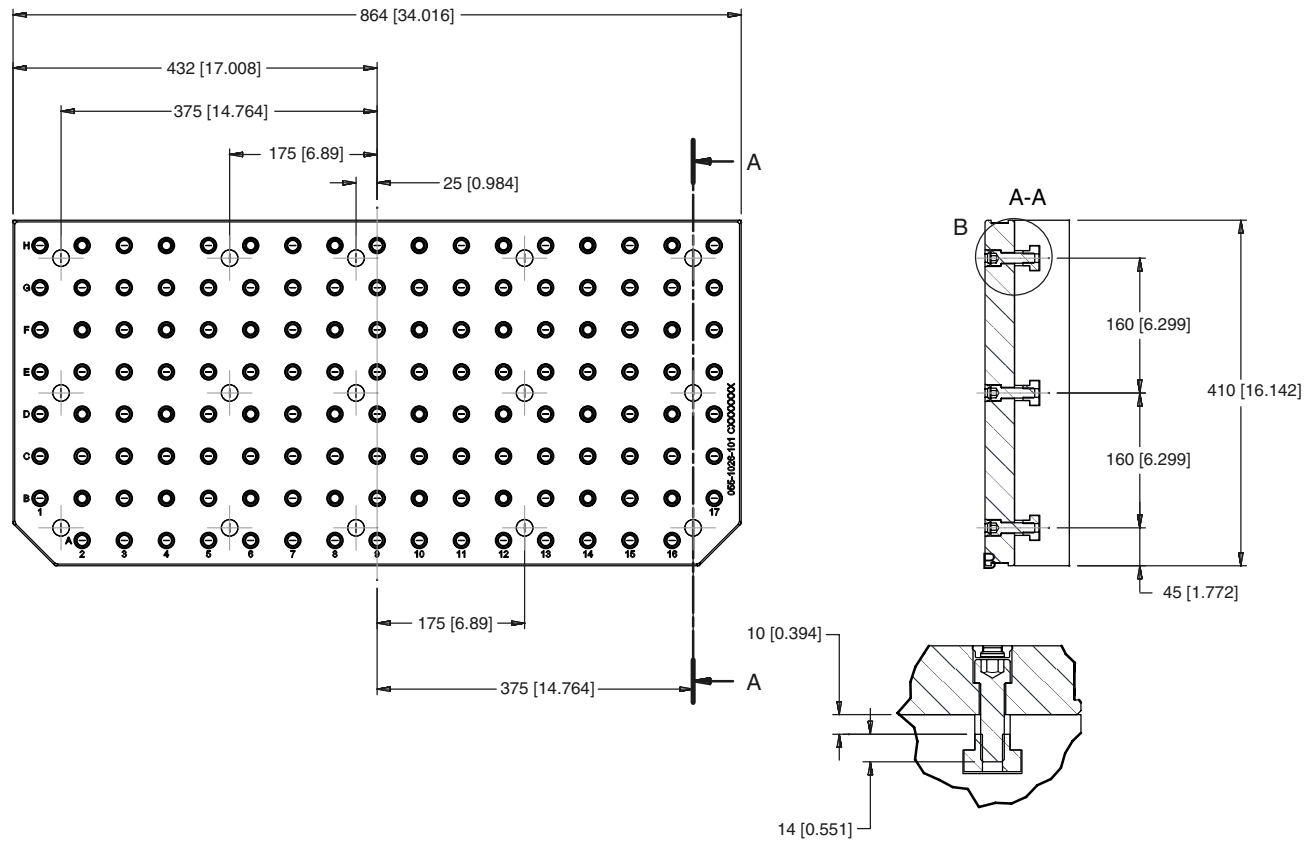

Notes  
All dimensions are MM [IN]

**CHICK WORKHOLDING SOLUTIONS, INC**  
 500 Keystone Drive • Warrendale, PA 15086 USA  
 Phone: (724) 772-1644 • Fax: (724) 772-1633  
 Toll Free: (800) 33-CHICK • (800) 332-4425  
[www.ChickWorkholding.com](http://www.ChickWorkholding.com)

# 5VP-KITA-00055

This workholding package is designed for your KITAMURA 3XiF-Sparkchanger machining center.

FOUNDATION LENGTH, DEPTH, AND MOUNTING HOLE CONFIGURATION DESIGNED ACCORDING TO MACHINE TOOL SPECIFICATION

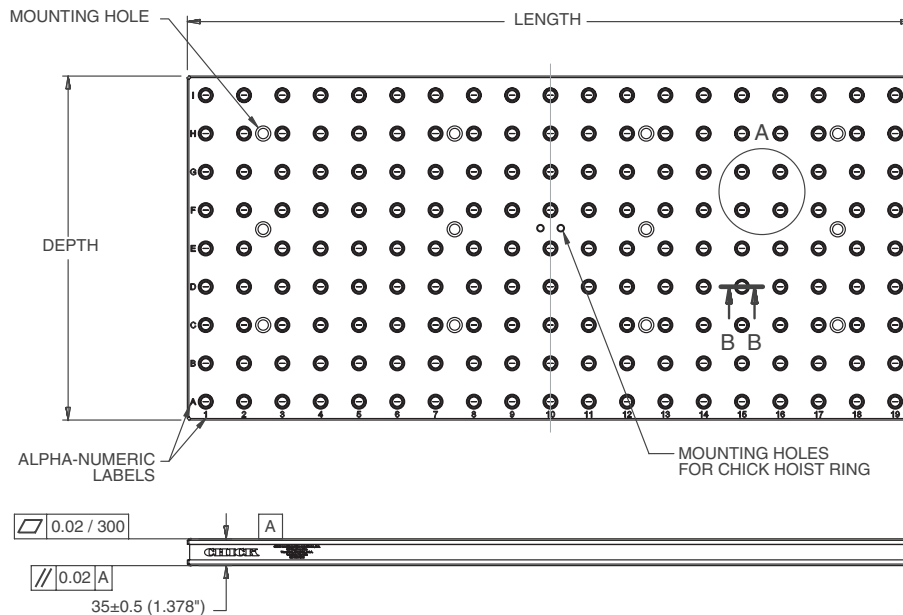

FOUNDATION MAT'L: CAST IRON  
FOUNDATION INCLUDES INSTALLATION HARDWARE

### DETAIL A

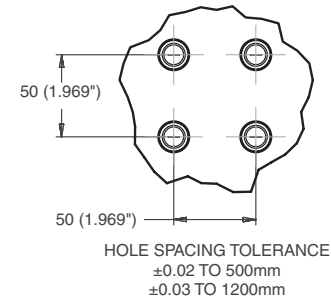

### SECTION B-B

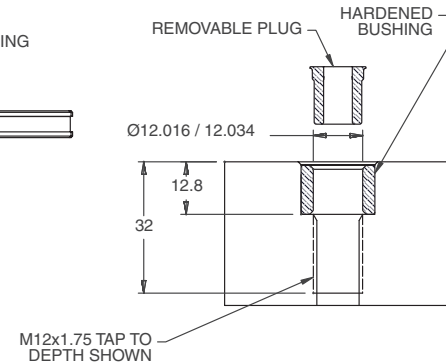

Notes  
All dimensions are MM [IN]

**CHICK WORKHOLDING SOLUTIONS, INC**  
500 Keystone Drive • Warrendale, PA 15086 USA  
Phone: (724) 772-1644 • Fax: (724) 772-1633  
Toll Free: (800) 33-CHICK • (800) 332-4425  
[www.ChickWorkholding.com](http://www.ChickWorkholding.com)

## Batch Production

Machinable accessories are the optimal solution for batch production. They offer QwikChange™ and accurate repeat set ups to optimize the productivity of the machine center.

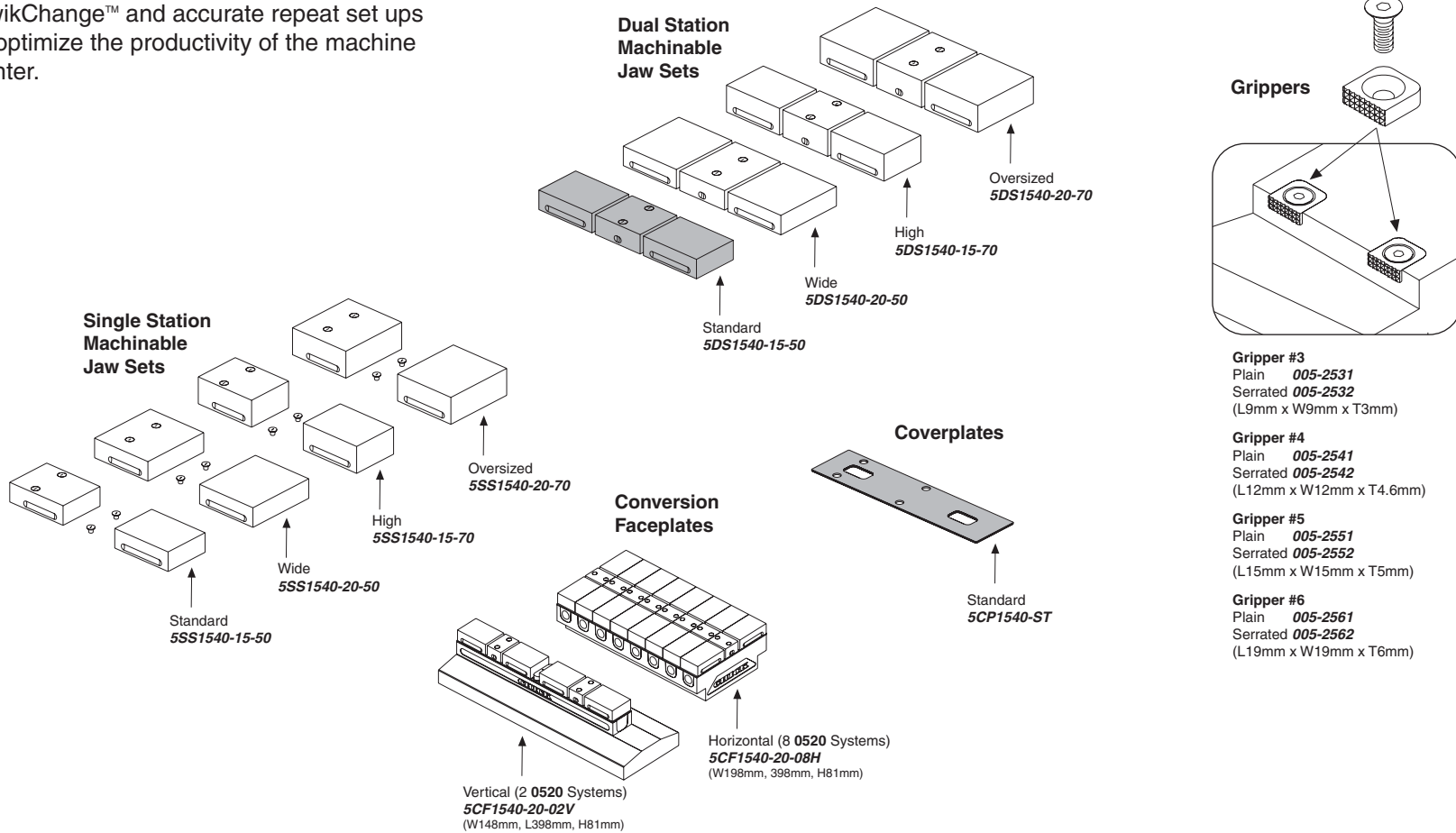

**Notes**

Grey item is included with a standard system

**CHICK WORKHOLDING SOLUTIONS, INC**  
 500 Keystone Drive • Warrendale, PA 15086 USA  
 Phone: (724) 772-1644 • Fax: (724) 772-1633  
 Toll Free: (800) 33-CHICK • (800) 332-4425  
[www.ChickWorkholding.com](http://www.ChickWorkholding.com)

## Dedicated Fixturing

Machinable Faceplates provide QwikChange™ dedicated fixturing and are optimal for awkward or hard to hold parts. A mini pallet changer can be created by utilizing two Faceplates in tandem.

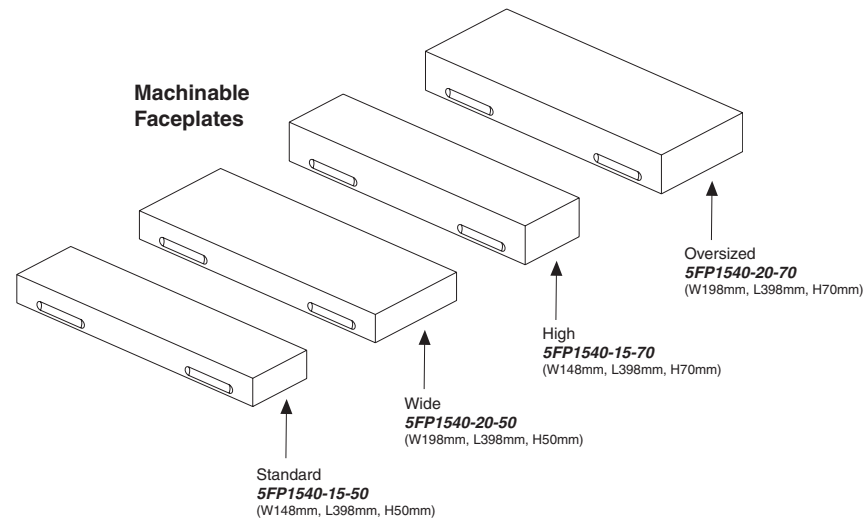

Notes

**CHICK WORKHOLDING SOLUTIONS, INC**  
500 Keystone Drive • Warrendale, PA 15086 USA  
Phone: (724) 772-1644 • Fax: (724) 772-1633  
Toll Free: (800) 33-CHICK • (800) 332-4425  
[www.ChickWorkholding.com](http://www.ChickWorkholding.com)

## QwikChange Machinable Dual Station Jaws

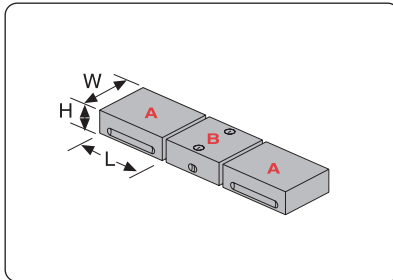

### Individual Dual Station Jaws

Standard	
<b>A</b> Moveable Jaw .....	<b>5MJ1540-15-50</b> (W148mm, H50mm, L135mm)
<b>B</b> Fixed Jaw .....	<b>5FJ1540-15-50</b> (W148mm, H50mm, L100mm)
Wide	
<b>A</b> Moveable Jaw .....	<b>5MJ1540-20-50</b> (W198mm, H50mm, L135mm)
<b>B</b> Fixed Jaw .....	<b>5FJ1540-20-50</b> (W198mm, H50mm, L100mm)
High	
<b>A</b> Moveable Jaw .....	<b>5MJ1540-15-70</b> (W148mm, H70mm, L135mm)
<b>B</b> Fixed Jaw .....	<b>5FJ1540-15-70</b> (W148mm, H70mm, L100mm)
Oversized	
<b>A</b> Moveable Jaw .....	<b>5MJ1540-20-70</b> (W198mm, H70mm, L135mm)
<b>B</b> Fixed Jaw .....	<b>5FJ1540-20-70</b> (W198mm, H70mm, L100mm)

## QwikChange Machinable Single Station Jaws

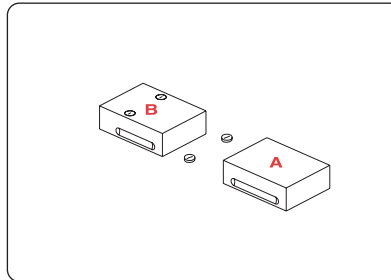

### Individual Single Station Jaws

Standard	
<b>A</b> Moveable Jaw .....	<b>5MJ1540-15-50</b> (W148mm, H50mm, L135mm)
<b>B</b> Fixed Jaw .....	<b>5SJ1540-15-50</b> (W148mm, H50mm, L135mm)
Wide	
<b>A</b> Moveable Jaw .....	<b>5MJ1540-20-50</b> (W198mm, H50mm, L135mm)
<b>B</b> Fixed Jaw .....	<b>5SJ1540-20-50</b> (W198mm, H50mm, L135mm)
High	
<b>A</b> Moveable Jaw .....	<b>5MJ1540-15-70</b> (W148mm, H70mm, L135mm)
<b>B</b> Fixed Jaw .....	<b>5SJ1540-15-70</b> (W148mm, H70mm, L135mm)
Oversized	
<b>A</b> Moveable Jaw .....	<b>5MJ1540-20-70</b> (W198mm, H70mm, L135mm)
<b>B</b> Fixed Jaw .....	<b>5SJ1540-20-70</b> (W198mm, H70mm, L135mm)

## Screws and Plugs

### Dual Station

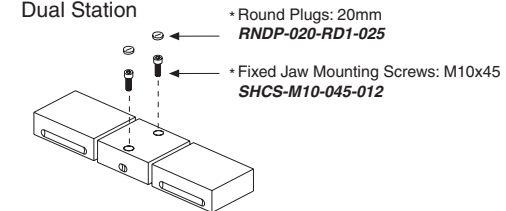

### Single Station

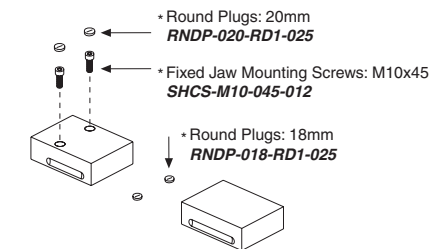

## Faceplate Round & Diamond Pin Set

(Included w/ Faceplate purchase)

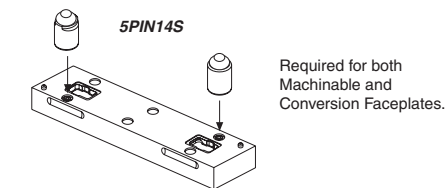

### Notes

Grey or \* item is included with a standard system

**CHICK WORKHOLDING SOLUTIONS, INC**  
500 Keystone Drive • Warrendale, PA 15086 USA  
Phone: (724) 772-1644 • Fax: (724) 772-1633  
Toll Free: (800) 33-CHICK • (800) 332-4425  
[www.ChickWorkholding.com](http://www.ChickWorkholding.com)





**Dual Station**

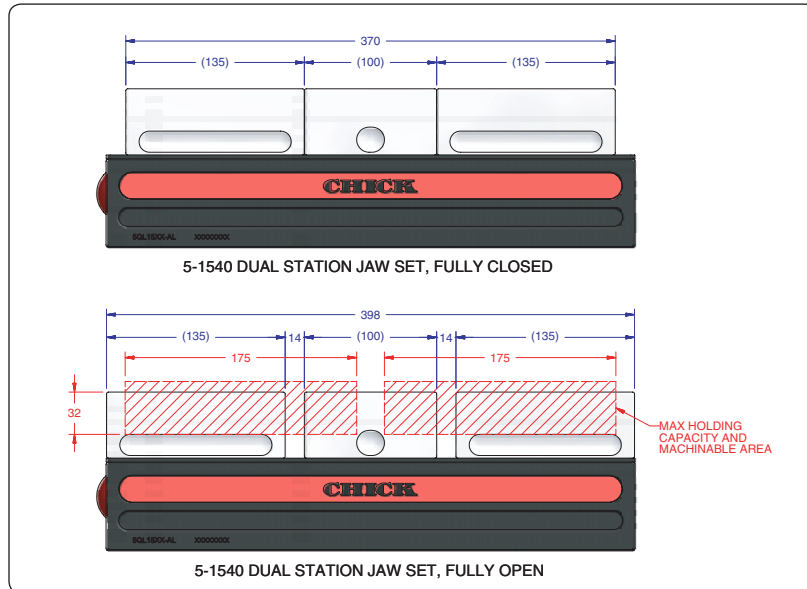

Item Number	Description	A	Jaw Width
5DS1540-15-50	Standard	32 [1.26]	148 [5.83]
5DS1540-15-70	High	52 [2.05]	148 [5.83]
5DS1540-20-50	Wide	32 [1.26]	198 [7.80]
5DS1540-20-70	Oversized	52 [2.05]	198 [7.80]

**Single Station**

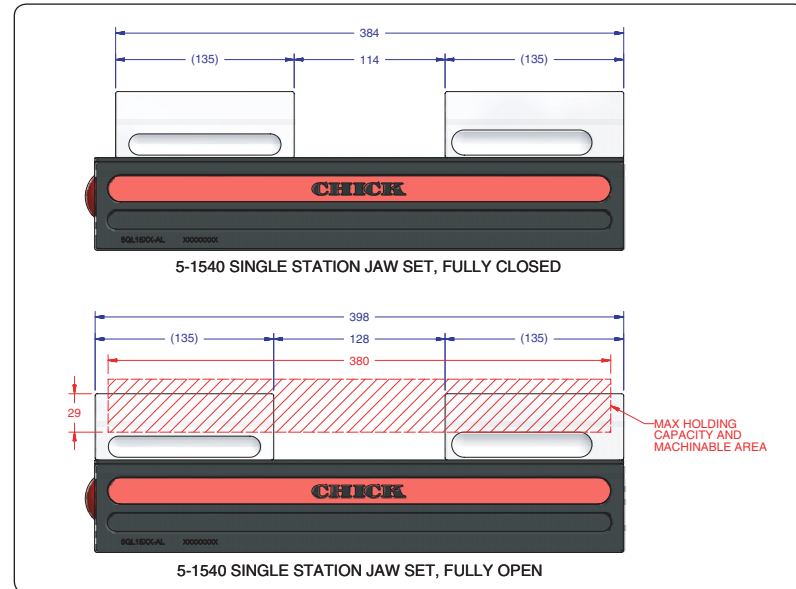

Item Number	Description	A	Jaw Width
5SS1540-15-50	Standard	29 [1.14]	148 [5.83]
5SS1540-15-70	High	49 [1.93]	148 [5.83]
5SS1540-20-50	Wide	29 [1.14]	198 [7.80]
5SS1540-20-70	Oversized	49 [1.93]	198 [7.80]

**Notes**

All dimensions are MM [IN]  
 Additional closure is available with an Extended Travel Coverplate.  
 Contact CHICK for details.

**CHICK WORKHOLDING SOLUTIONS, INC**  
 500 Keystone Drive • Warrendale, PA 15086 USA  
 Phone: (724) 772-1644 • Fax: (724) 772-1633  
 Toll Free: (800) 33-CHICK • (800) 332-4425  
[www.ChickWorkholding.com](http://www.ChickWorkholding.com)

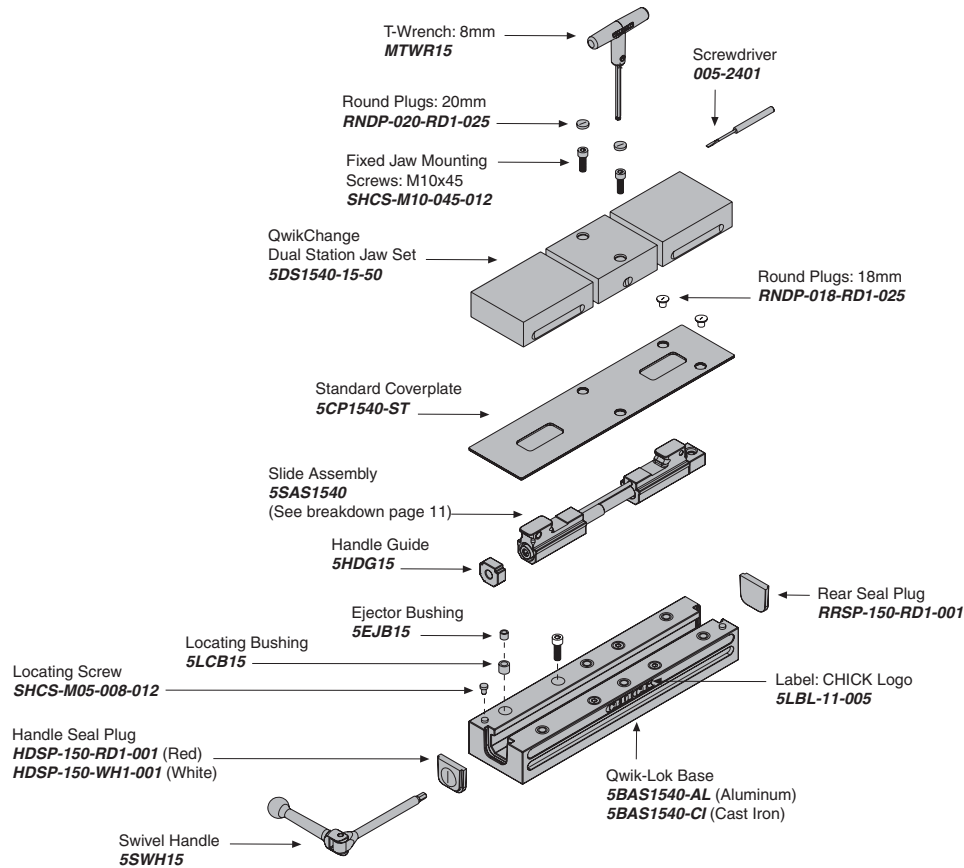

## MOUNTING

### Foundation

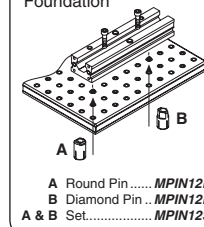

### T-Slotted Table

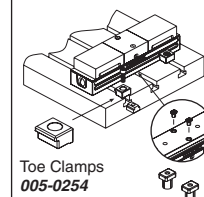

Bolt and T-Nut  
 supplied by customer

### Bottom of Base

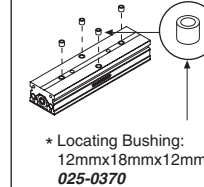

### Locating Keys

Inch Size	
MKE500	(1/2")
MKE562	(9/16")
MKE625	(5/8")
MKE688	(11/16")
MKE750	(3/4")
MKE812	(13/16")
Metric Size	
MKE10	(10mm)
MKE12	(12mm)
MKE14X18	(14mm)
MKE16	(16mm)
MKE20	(20mm)

## Notes

Grey items are included with a standard system  
 For QwikChange™ Jaw accessories, see pages 5-8

**CHICK WORKHOLDING SOLUTIONS, INC**  
 500 Keystone Drive • Warrendale, PA 15086 USA  
 Phone: (724) 772-1644 • Fax: (724) 772-1633  
 Toll Free: (800) 33-CHICK • (800) 332-4425  
[www.ChickWorkholding.com](http://www.ChickWorkholding.com)

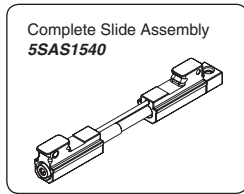

**Notes**

Grey items are included with a standard system

**CHICK WORKHOLDING SOLUTIONS, INC**  
 500 Keystone Drive • Warrendale, PA 15086 USA  
 Phone: (724) 772-1644 • Fax: (724) 772-1633  
 Toll Free: (800) 33-CHICK • (800) 332-4425  
[www.ChickWorkholding.com](http://www.ChickWorkholding.com)

**Pounds (lbs)**

Force	=	Torque	X	Slope
lbs	=	in-lb	x	6.4
lbs	=	ft-lbs	x	76.3

Torque (ft-lb)	Force (lbs)
0	0
10	763
20	1525
30	2288
40	3051
50	3814
60	4576
70	5339
80	6102
90	6864
95	7246
100	7627
105	8008
110	8390
115	8771
118	9000

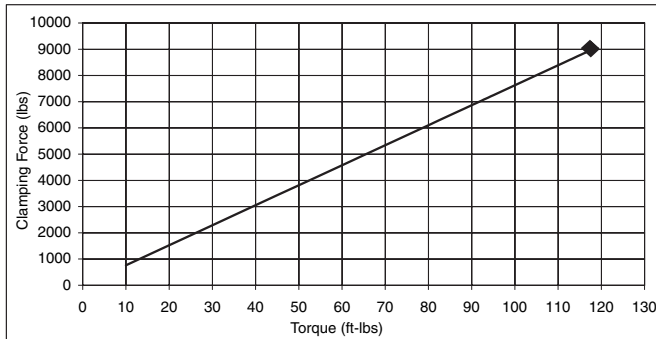

Note: **◆** Maximum Recommended Torque. Actual results may vary.

**Kilonewtons (kN)**

Force	=	Torque	X	Slope
N	=	N-m	x	250
kN	=	N-m	x	0.25

Torque (N-m)	Force (kN)
0	0.0
10	2.5
20	5.0
30	7.5
40	10.0
50	12.5
60	15.0
70	17.5
80	20.0
90	22.5
100	25.0
110	27.5
120	30.0
130	32.5
140	35.0
150	37.5
160	40.0

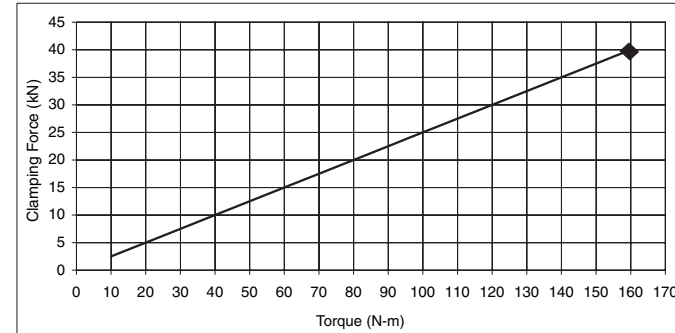

Note: **◆** Maximum Recommended Torque. Actual results may vary.

Notes

**CHICK WORKHOLDING SOLUTIONS, INC**  
 500 Keystone Drive • Warrendale, PA 15086 USA  
 Phone: (724) 772-1644 • Fax: (724) 772-1633  
 Toll Free: (800) 33-CHICK • (800) 332-4425  
[www.ChickWorkholding.com](http://www.ChickWorkholding.com)